

BONGSHIN[®]



OPERATIONAL MANUAL



BS-750

DIGITAL INDICATOR

CONTENTS

INTRODUCTIONS	2
THE FEATURES OF BS-750 . . .	3
TECHNICAL SPECIFICATION . .	4
DIMENSIONS	6
FRONT PANEL	7
REAR PANEL.	10
CALIBRATION MODE	12
SIMULATION MODE	16
SET MODE	19
SERIAL INTERFACE	28
OPTION	32
Error Message	
And Trouble Shooting	33

INTRODUCTIONS

1. INTRODUCTION

We greatly appreciate your purchase of the BONGSHIN industrial indicator. These goods perform excellently and exhibit splendid properties through strike tests.

BONGSHIN indicator is delicately designed to coincide with the special requirements of several industrial fields and includes many functions and various external interfaces. Also, it is programmed for the user's convenience and contains help display functions that are easily accessible.

Before using **BS-750**, It is recommended that you read this manual carefully so you may use this device to its full potential.

2. PRECAUTIONS

- Place the indicator on a flat and stable surface.
- Do not severely press because the light pressing of keys can incite the operation.
- Do not subject the scale to sudden temperature changes.
Operating temperature : $-10^{\circ}\text{C}\sim 40^{\circ}\text{C}$ ($+14^{\circ}\text{F} \sim +104^{\circ}\text{F}$)
- Keep the scale away from strong EMI noises may cause incorrect weight readings.
- Keep the main body from rain and keep in dry area.
- Do not use inflammable materials in cleaning.

THE FEATURES OF BS-750

1. Features

- Appropriate for weight and measurement system.
- Easy operation and various options.
- Simple full digital calibration.
- Watchdog circuitry (system restoration)
- Weight Back-up (power on actual weight)

2. Main Function

- Various specification of weight conversion speed.
(Digital Filter Function)
- Various printer connection. (RS-232C Serial Printer)
- RS-232C standard
- User can set the max. weight which users want to and division at one's disposal.

TECHNICAL SPECIFICATION

1. Analog Input & A/D Conversion

Load cell excitation Voltage	DC 5V, up to 4 x 350ohm load cells
Input sensitivity	0.3 $\mu\text{V}/\text{D}$
System linearity	Within 0.01% F.S.
Zero adjust range	0mV ~ 20mV
Input Voltage	Max. 20mV Min. 5mV
Accuracy	Zero drift : $\pm 0.2 \mu\text{V}/\text{C}$ RTI max. Span drift : 20ppm/ C max.
Input Noise	$\pm 0.3 \mu\text{V}$ p.p or less
Input Impedance	10 $\text{M}\Omega$ (Min.)
A/D converter	Sigma-Delta system
A/D internal resolution	Approximately 200,000 counts
A/D external resolution	1/30,000 (Max.)
A/D conversion speed	10 times/sec
Max. resolution	1/30,000

2. Digital Part

Display	7 Segment LED, 6-Digits, 20.30mm(Height)
Display below zero	"-" minus signal
Additional symbols	Zero, Stable, Net, Tare, Hold
Min. Division	x 1, x 2, x 5, x 10, x 20, x 50
Decimal Point	0, 0.0, 0.00, 0.000

3. Technical

AC adapter	AC 230V, 50/60Hz (DC9V, 1000mA Adaptor)
Power consumption	10 W
Data Memory	10 year
Operating temperature	-10°C~+40°C (+14°F ~ +104°F)
Humidity	85% Rh Max.
Overall dimensions	175(W) x 53(D) x 160(H)
Weight	1.0 kg

4. Option

Standard	Serial Interface : RS-232C
Option - 1	Serial Interface : RS-422/485



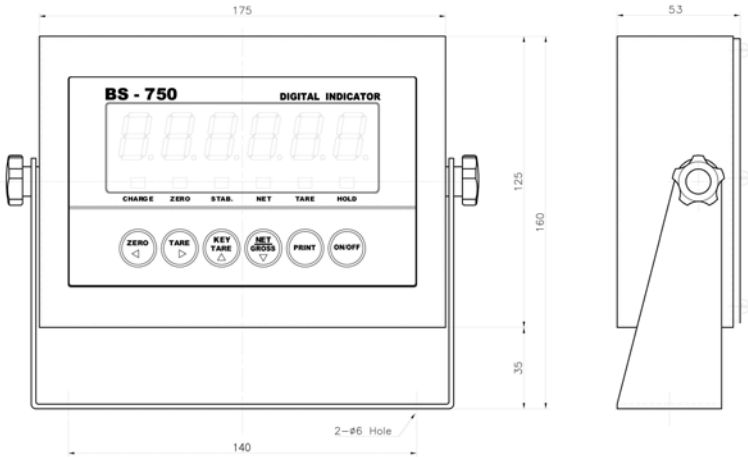

DIMENSIONS

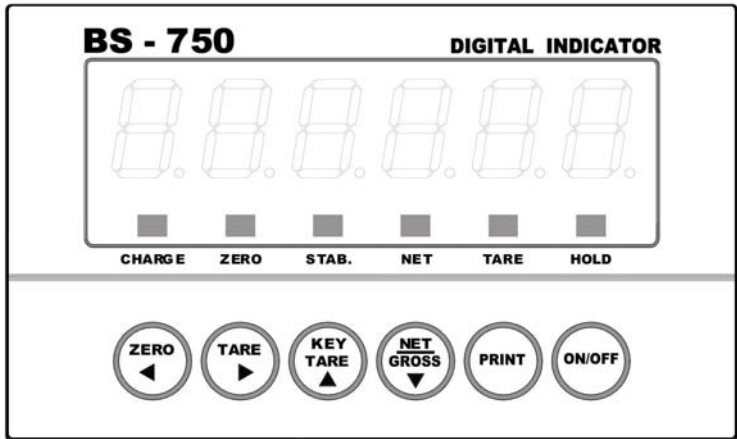





Front Panel



1. Display Lamp ()

-  **ZERO lamp** : ON when the current weight is 0 kg.
-  **STABLE lamp** : ON when the weight is stable.
-  **NET lamp** : ON when the current weight is NET weight.
-  **TARE lamp** : ON when the tare weight is stored.
-  **HOLD lamp** : Lamp is on when moving object is weighed.

2. Keyboard

-  Available keys instead of numeric keys.
Change the set value
-  Increases (Decrease) the first place value to 1.
-  Change the digit of the set value.
Move to the right (left) by 1 place.
-  Usage-input the numeric value in CAL, SIM, SET mode.



Returns the display to 0



- automatic tare weight input -

Use container in weighing.

Current weight is memorized as tare weight.

If you press TARE key in unload condition, Tare setting is released automatically.



- manual tare weight input -

When you already know the tare weight, press key tare and input tare weight with arrow keys and memorize it by pressing ON/OFF(ENTER) key.



Use container in weight.

NET lamp off – gross weight

NET lamp on –net weight

In case tare weight is registered, tare and item's total weight is G. weight and only item's weight is N. weight.



PRINT key

■ **Print key** → Set in F23 : 1

■ **Hold key** → Set in F23 : 2

■ **SET mode**

→ By pressing “PRINT” key more than 3 seconds.



■ **ON/OFF key**

■ **Total Print key** → Set in F24 :1

Print both the present weighing value and total weighing value.

■ Store current condition and exit.

3. How to enter SET mode

By pressing “PRINT” key more than 3 seconds.

4. How to enter CAL mode

Slid switch usage

■ **Dip slide SW 1 – CAL Mode**

■ **Dip slide SW 2 – SIM Mode**

Rear Panel

■ **LOAD CELL** : cable gland for load cell

Pin no.	SIGNAL	
1	Shield	SHIELD
2	Load cell Input Voltage (-)	EXC- (white)
3	Load cell output (-)	SIG- (blue)
4	Load cell output (+)	SIG+ (green)
5	Load cell Input Voltage (+)	EXC+ (red)

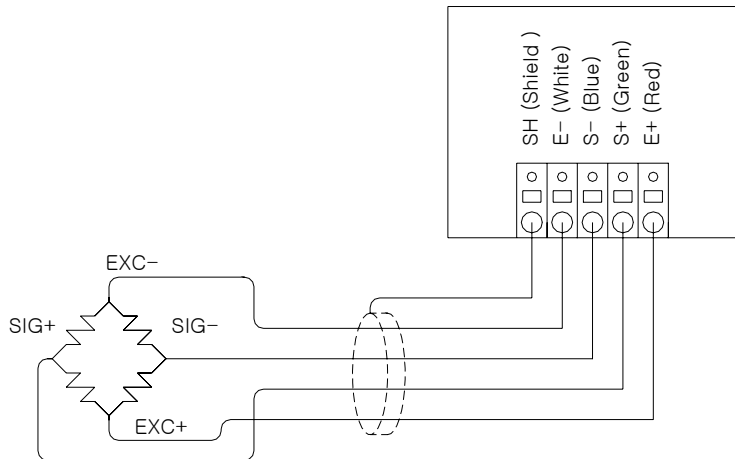

■ **RS-232C PORT** : Serial interface port. (computer, printer)

■ **AC ADAPTER** : Port for DC power. (DC 9V adapter are available)

► **REAR SLIDE SWITCH USAGE**

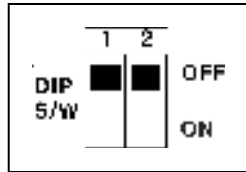

■ **Dip slide sw 1** : CALIBRATION mode

SW 1 ON : Shift to calibration mode.

Turn sw1 off after calibration, It returns to weighing mode.

■ **Dip slide sw 2** : SIMURATION CALIBRATION mode

SW 2 ON : Shift to simulation calibration mode.

Turn sw2 off after calibration, It returns to weighing mode.

Calibration mode

1. How to Enter

Turn on the power while CAL switch 1 on the rear panel of the indicator and CAL mode starts.

2. Available Keys



Increase the first place set value to 1.



Move to the left by 1 place of the set value.



Move into next menu.

3. Calibration Menu (CAL 1 ~ CAL 5)

CAL 1 : Maximum Capacity Set

CAL 2 : Minimum Division Set

CAL 3 : Setting Weight in span calibration

CAL 4 : Zero Calibration

CAL 5 : Span Calibration

■ CAL 1

- Function : **Maximum Capacity Set**

Range → 1 ~ 99,999kg

Key	Display	Description
▲▼ : Increase	CAL 1	CAL 1 condition.
◀▶ : Shift of digit	C 100	100 kg
“ON/OFF” key :	C 10000	10000kg
Store and move into next menu		

☞ REF 1. The maximum capacity means the maximum weight that scale can measure.

■ CAL 2

- Function : **Minimum Division Set**

Range → 1~ 50

Key	Display	Description
▲▼ : Increase	CAL 2	CAL 2 condition.
“ON/OFF” key :	d 1	1 kg (Decimal point : 0)
Store and move into next menu	d 1	0.01kg (Decimal point: 2)

☞ REF 1. The minimum division means the value of one division.

☞ REF 2. External resolution is obtained by division the min. division by the maximum capacity. Set the resolution to be within 1/30,000.

■ CAL 3

- Function : **Setting Weight In Span Calibration**

Range → 1~ 99,999kg

Key	Display	Description
▲▼ : Increase	CAL 3	CAL 3 "ON/OFF" key :
◀▶ : Shift of digit	L 100	100 kg
"ON/OFF" key :	L 10000	10000kg
Store and move into next menu		Setting Weight

- ☞ REF 1. The weight shall be within the range of 10%~100% of maximum weight.
- ☞ REF 2. The setting weight must be over the range of 10% of maximum weight.
- ☞ REF 3. The setting weight over the maximum capacity.

■ CAL 4

- Function : **Zero Calibration**

Key	Display	Description
"ON/OFF" key :	CAL 4	CAL 4 condition.
Zero calibration	UnLoad	Unload the tray and press "ON/OFF" key
and move into	-----	Under zero calibration
next menu	SUCCESS	Zero calibration is completed.

- ☞ REF 1. If zero calibration is done without any error, "SUCCESS" message is displayed and program moves into CAL 5 automatically.
- ☞ REF 2. If the "ZERO" key is pressed, only zero calibration is completed and program moves SAVE & EXIT mode. Turn sw1 off.

■ CAL 5

– Function : **Span Calibration**

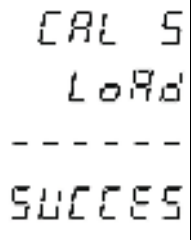
Key	Display	Description
“ON/OFF” key : Span calibration and move into next menu	 <p>The display shows the following sequence of messages: "CAL 5", "Load", a dashed line "-----", and "SUCCESS".</p>	CAL 5 condition. Load the weight which was set in CAL3 and press “ON/OFF” key. Under span calibration Span calibration is completed. Turn sw1 off. (Save & exit CAL mode)

- ☞ REF 1. If zero calibration is done without any error, “SUCCESS” message is displayed the weight of setting weight is displayed on LED screen.
Check the weight.
- ☞ REF 2. Check the weight of setting weight and turn sw1 off and calibration is completed.

Simulation Calibration mode

1. How to Enter

Turn on the power while CAL switch 2 on the rear panel of the indicator and CAL mode starts.

2. Available Keys



Increase the first place set value to 1.



Move to the left by 1 place of the set value.



Move into next menu.

3. Calibration Menu (Sim 1 ~ Sim 4)

Sim 1 : Maximum Capacity Set

Sim 2 : Minimum Division Set

Sim 3 : Rated Output Set

Sim 4 : Zero Calibration

■ Sim 1

– Function : **Maximum Capacity Set**

Range → 1 ~ 99,999kg

Key	Display	Description
▲▼ : Increase	5 17 1	Sim 1 condition.
◀▶ : Shift of digit	L 100	100 kg
“ON/OFF” key :	L 10000	10000kg
Store and move into next menu		

☞ REF 1. The maximum capacity means the maximum weight that scale can measure.

■ Sim 2

– Function : **Minimum Division Set**

Range → 1~ 50

Key	Display	Description
▲▼ : Increase	5 17 2	Sim 2 condition.
“ON/OFF” key :	d 1	1 kg (Decimal point : 0)
Store and move into next menu	d 1	0.01kg (Decimal point: 2)

☞ REF 1. The minimum division means the value of one division.

☞ REF 2. External resolution is obtained by division the min. division by the maximum capacity. Set the resolution to be within 1/30,000.

■ Sim 3

- Function : **Rated Output Set**

Range → 1mV/V ~ 3mV/V

Key	Display	Description
▲▼ : Increase	5 1̄ 3	Sim 3 condition.
◀▶ : Shift of digit	10000	1mV/V
“ON/OFF” key : Store and move into next menu	20000	2mV/V

■ Sim 4

- Function : **Zero Calibration**

사용 키	FND 화면	설 명
“ON/OFF” key :	5 1̄ 4	Sim 4 condition.
Zero calibration	UnLoAd	Unload the tray and press “ON/OFF” key
and move into	-----	Under zero calibration
next menu	SUCCESS	Zero calibration is completed & Span calibration is completed. Turn sw2 off. (Save & exit CAL mode).

☞ REF 1. If zero calibration is done without any error, “SUCCESS” message is displayed the weight of setting weight is displayed on LED screen.

Check the weight.

☞ REF 2. Check the weight of setting weight and turn sw2 off and calibration is completed.

SET MODE

1. How to Enter

By pressing “PRINT” key more than 3 seconds.

At this time, “F01” message is displayed on FND screen after “SET” message.

- ① “F01” : Call the function which you want to convert.
- ② Input function no. to convert with arrow keys and press ON/OFF key.
- ③ “F01-1” : Means call the function which you would convert.
- ④ Input function no. to convert and press ON/OFF key.

2. How to Exit

By pressing “PRINT” key more than 3 seconds.

3. Available Keys



Increase the first place set value to 1.



Move to the left by 1 place of the set value.



SET mode starts.

Store current condition and SET mode exit.



Move into next menu.

4. Set Value Conversion Menu (F01~F46)

▶ General Function

- F01 Decimal Point Adjustment
- F02 Weighing Unit Change
- F03 Display Update Rate
- F04 Digital Filter
- F05 Motion Detection Condition
- F06 Automatic ZERO Tracking Compensation
- F07 Weight Backup
- F08 Set ZERO Range
- F09 ZERO & TARE Keys Availability
- F10 Set Hold Type
- F22 Device ID
- F23 Designation of "PRINT" key usage
- F24 Designation of "ON/OFF" key usage

▶ Serial Interface

- F31 Designation of "COM1" usage
- F32 Designation of Baud Rate
- F33 Designation of Output Mode

▶ PRINTER

- F42 Auto Print/ Manual Print
- F43 Designation of Printing Format
- F45 Date change
- F46 Time change

► **General Function**

Decimal Point Adjustment			
F01	0	No decimal point	0
	1	10^1	0.0
	2	10^2	0.00
	3	10^3	0.000

Weighing Unit Change			
F02	0	g	gram
	1	kg	kilogram
	2	t	ton
	3	lb	pound

Display Update Rate			
F03	0	10 Times/sec	
	1	5 Times/sec	

Digital Filter			
F04	1	1 : Less vibration	Adjust the set value according to the condition how many times converted digital value read and display.
	~	~	
	9	9 : Much vibration	

Motion Detection Condition			
F05	0	No motion Detection Condition	
	1	1 : Less vibration	If weight change within given time is not bigger than the SET range, stable condition is displayed..
	~	~	
	9	9 : Much vibration	

Automatic Zero Tracking Compensation			
F06	0	None automatic zero	
	1	1 : 0.5 digit	Auto-zero tracking will automatically bring the display back to "0" when there are small deviations..
	~	2 : 1 digit	
		3 : 1.5 digit	
9	9 : 4.5 digit		

Weight Backup			
F07	0	Weight back-up is OFF (Power on zero)	
	1	Weight back-up is ON (Display setting weight)	

 REF. Memorize the current weight at sudden power failure.

Set Zero Range			
F08	0	3% : within 3% of MAX. weight	
	1	10% : within 10% of MAX. weight	
	2	100% : within 100% of MAX. weight	

Zero & Tare keys Availability			
F09	0	Works when weight is stable	
	1	Always	

Set Hold Type			
F10	0	Average Hold : Compute the average weight of oscillating weights.	
	1	Peak Hold : Compute the maximum weight of oscillating weights.	
	2	Instant Hold : The instant display value can now be held by pressing button.	

Device ID			
F22	00	00 : Device ID "0"	It is used the no. of indicator when system is connected.
	~		
	99	99 : Device ID "99"	

"PRINT" key usage		
F23	0	Not used
	1	Print key
	2	Hold key

"ON/OFF" key usage		
F24	0	ON/OFF of display
	1	Total Print key

► **RS-232C Interface**

COM 1 usage		
F31	0	Connection with computer and sub-display(BLD-236/425)

Baud Rate		
F32	0	600 bps (bit per second)
	1	1200 bps
	2	2400 bps
	3	4800 bps
	4	9600 bps

Output Mode (unit of speed in data transmission)		
F33	0	No data output
	1	Stream mode
	2	Transmit only in stable condition
	3	Transmit when data is required → Request signal : device ID(F22 : Device ID) → In case F22 : 1, send hex value 01H in computer

► **RS-232C Interface (PRINTER, REMOTE DISPLAY)**

COM 2 usage		
F34	0	Printer
	1	Remote Display (BLD-235/236/425)

Baud Rate		
F35	0	600 bps
	1	1200 bps
	2	2400 bps
	3	4800 bps
	4	9600 bps

Output Mode		
F36	0	No data output
	1	Stream Mode
	2	Transmit only in stable condition

► **PRINTER (F34 :0)**

Automatic Print		
F42	0	Manual print
	1	Automatic print

REF. If automatic print is set, printing is done without pressing PRINT key.

PRINTING FORMAT		
F43	0	Printing Format 0
	1	Printing Format 1
	2	Printing Format 2

PRINTING FORMAT 0		
DATE, TIME		
SERIAL, NET WEIGHT		
2002. 7. 22		12 : 30
001,		100.0 kg
002,		100.4 kg
003,		100.2 kg
004,		150.0 kg

TOTAL		450.6 kg

PRINTING FORMAT 1		
DATE, TIME		
SERIAL, NET WEIGHT		
2002. 7. 22		12 : 30
001,		100.0 kg
2002. 7. 22		12 : 32
002,		100.4 kg
2002. 7. 22		12 : 35
003		100.2 kg
2002. 7. 22,		12 : 50
004,		150.0 kg

TOTAL		450.6 kg

PRINTING FORMAT 2

DATE, TIME
G. WEIGHT, TARE WEIGHT,
NET WEIGHT

2002. 7. 22	12 : 30
GROSS :	100.0 kg
TARE :	0.0 kg
NET :	100.0 kg
2002. 7. 22	12 : 32
GROSS :	100.4 kg
TARE :	0.0 kg
NET :	100.4 kg
2002. 7. 22	12 : 35
GROSS :	100.2 kg
TARE :	50.0 kg
NET :	50.2 kg

TOTAL 250.6 kg

DATE CHANGE			
	KEY	Display	Meaning
F45	▲▼ : Increase	0 2 . 0 5 . 1 8	MAY. 18th, 2002
	◀▶ : Shift of digit		
	“ON/OFF” key :		
	Store and move into next menu		

시간 변경			
	KEY	Display	Meaning
F46	▲▼ : Increase	1 3 . 3 0 . 5 0	PM 1 : 30 : 50
	◀▶ : Shift of digit		
	“ON/OFF” key :		
	Store and move into next menu		

Serial Interface (Standard)

1. RS-232C Serial Interface

► RS-232C Port Connection

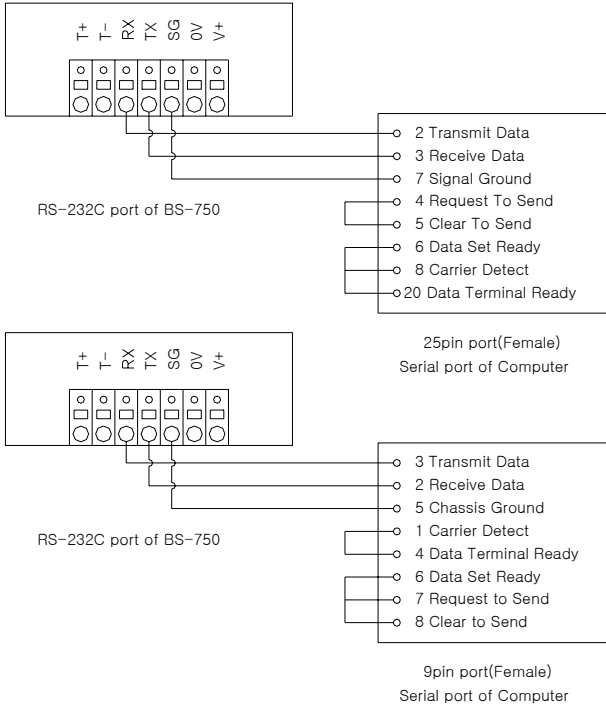

► Signal Format

- **Type** : EIA-RS-232C
- **Method** : Full-Duplex , Asynchronous, Bi-direction
- **Baud rate** : 600, 1200, 2400, 4800, 9600bps (Baud-Rate)
- **Format** :

① Data Bit	:	8 (NO Parity)
② Start/Stop	:	1 bit
③ Parity Bit	:	None
④ Code	:	ASCII

■ Data Format (22 byte)

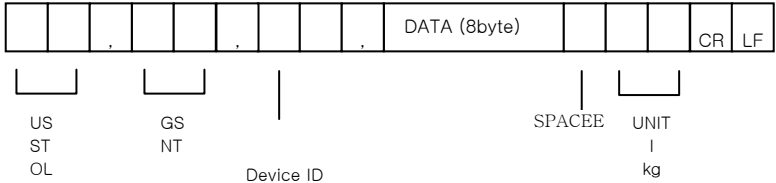

① Header 1

- US : WEIGHT UNSTABLE
- ST : WEIGHT STABLE
- OL : OVER LOAD

② Header 2

- GS : GROSS WEIGHT MODE
- NT : NET WEIGHT MODE

③ Device ID

Transmit 1 byte device ID so that the receiver can receive data selectively which indicator send.

Insert in case of except SETUP F22-“00”

④ WEIGHT (8 byte)

- SIGNAL (+ or -)
- WEIGHT (Included Decimal point)
 - 100.0 kg : ‘0’, ‘0’, ‘0’, ‘1’, ‘0’, ‘0’, ‘.’, ‘0’,
 - 150.5 kg : ‘0’, ‘0’, ‘0’, ‘1’, ‘5’, ‘0’, ‘.’, ‘5’,
 - 165.3 kg : ‘-’, ‘0’, ‘0’, ‘1’, ‘6’, ‘5’, ‘.’, ‘3’,

Each ASCII code of weight transmitted by 8 byte.(‘0’ : 0 x 20)

⑤ Data for Number

- 2B(H) “ + ” : PLUS
- 2D(H) “ - ” : MINUS
- 2O(H) “ ” : SPACE
- 2E(H) “ . ” : Decimal Point

⑥ Unit

- g : Unit of gram
- kg : Unit of kilogram
- t : Unit of ton
- lb : Unit of pound

► Simple Interface Program**■ Basic Program**

```
10 OPEN "COM1:9600,N,8,1" As #1
20 IF LOC(1) = 0 THEN 60
30 A$ = INPUT$(1,1)
40 PRINT A$ ; " ";
50 GOTO 20
60 B$=INKEY$ : IF B$ = " " THEN 20
70 PRINT B$ ; " ";
80 PRINT #1,B$;
90 GOTO 20
```

■ C Program

```
#include <bios.h>
#include <conio.h>
#define COM1 0
#define DATA_READY 0×100
#define TRUE 1
#define FALSE 0
#define SETTINGS 0×E3
int main(void)
```

```
{
    int in, out, status, DONE = FALSE;
    bioscom(0, SETTINGS, COM1);
    cprintf("...BIOSCOM [ESC] to exit ...\\n");
    while (!DONE)
    {
        status = bioscom(3, 0, COM1);
        if (status & DATA_READY)
            if ((out = bioscom(2, 0, COM1) & 0x7F) != 0)
                putchar(out);
            if (kbhit())
            {
                if ((in = getch()) == '\\x1B')
                    DONE = TRUE;
                bioscom(1, in, COM1);
            }
    }
    return 0;
}
```

Option

OPTION 1 : RS-422/485 Serial Interface

- RS-422 / 485 is to transmit the signal by the power difference.
Also, it is more safety rather other interface system for a electric noise.
- RS- 485 should be connected as follows.
RXD(+) + TXD(+), RXD(-) + TXD(-)
- Specially please use the cable with shield coax cable surely.
- Recommended distance is under 1.2 km.
- Both end side of a wire must be connected by the termination of 300Ω .

► RS-422 Port Connection

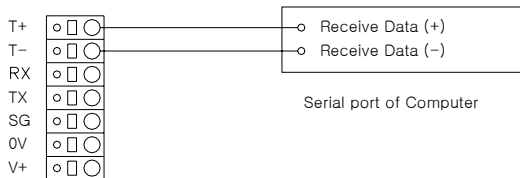

RS-422 port of BS-750

- **Signal Format** : Same as RS-232C
- **Data Format** : Same as RS-232C

Error Message and Trouble Shooting

1. Error in Weighing Mode

■ no LC

☞ Reason

Failure in load cell connection or error in A/D conversion part.

☞ Trouble shooting

Check the load cell connector so that you may see if the polarity of signal is reversed.

If the load cell output is too small

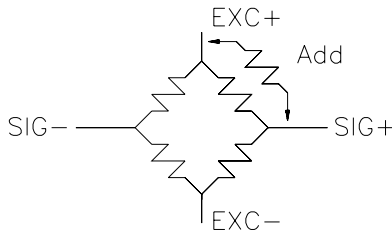

- ※ When adding a resistor, use a metal film resistor in the range 50 to 500K Ω with a good temperature coefficient.

Use as large a resistance value as possible in the range in which zero adjustment is possible.

If an error still occurs when the above method is used, check whether the load cell is defective or incorrectly connected.

■ Over

☞ Reason

The weight on platform is too heavy to be measured.

☞ Trouble shooting

Do not load the item exceeds the maximum tolerance.

If the load cell is damaged, the load cell should be replaced.

■ BUZZER

☞ Reason

Current weight deviates from zero range.

☞ Trouble shooting

Press the ZERO key within 10% of the maximum capacity.

(Function : F11 - x)

2. Error in Calibration Mode

■ no LC , no 1

☞ Reason

Failure in load cell connection or error in A/D conversion part.

☞ Trouble shooting

Check the load cell connector so that you may see if the polarity of signal is reversed.

If the load cell output is too small

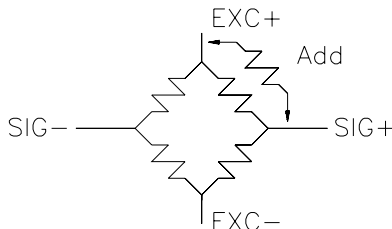

- ※ When adding a resistor , use a metal film resistor in the range 50 to 500K Ω with a good temperature coefficient.
Use as large a resistance value as possible in the range in which zero adjustment is possible.

If an error still occurs when the above method is used, check whether the load cell is defective or incorrectly connected.

■ Over

Reason

The weight on platform us too heavy to be measured.

The weight for span calibration is set to be exceeded 100% of the maximum capacity of the scale.

Trouble shooting

Do not load the item exceeds the maximum tolerance.

If the load cell is damaged, the load cell should be replaced.

Set the weight for span calibration is set to be within the maximum capacity of the scale in CAL 1.