

BONGSHIN[®]



OPERATIONAL MANUAL



BS-7300
DIGITAL INDICATOR

CONTENTS

PREFACE	2
TECHNICAL SPECIFICATION . .	5
DIMENSIONS	7
FRONT PANEL	8
REAR PANEL	11
INSTALLATION	15
CALIBRATION MODE (Actual) .	16
CALIBRATION MODE (Simulation)	29
SET-UP MODE	41
OPTION	50
Error Message	
And Trouble Shooting . . .	66

1. INTRODUCTION

Thank you very much for your purchasing BONGSHIN Digital Weighing Indicator of **BS-7300**.

This Instruction Manual will lead you to use **BS-7300** with top reliability, High speed, high accuracy.

BS-7300 is Digital Weighing Indicator amplifying the analog output from a load Cell, converting the analog signal to digital data and then displaying this data

As a weight reading and is designed for flawless performance in your demanding

Application of input-weighing, output-weighing, accumulating-weighing, 2step control.

Also, an additional option will make Modern Industry demand equipment that both versatile

And availed to easily connect to other devices

REMARK

- Specification subject to change for improvement without prior notice.
- If changing, the Version No can be increased, but keeps a former version

As far as possible

2. SAFTY CONDITIONS

Please keep the following **using conditions certainly**

■ EARTH

To avoid an electric error such as a noises in your production line It should be earthed before installation certainly.

Specially it will be safety to divide the power of Indicator into a load cell.

■ SAFTY CONDITIONS

Don't use it closed to a explosive gas and an inflammable dust environments

■ POWER

Use the power under 110/220V 50/60HZ $\pm 10\%$ and divide it into the power line

■ TEMPERTURE CONDITIONS

Operating Temperature : $-10^{\circ}\text{C} \sim +40^{\circ}\text{C}$ ($+14^{\circ}$ to 104°F)

Custody Temperature : $-40^{\circ}\text{C} \sim +80^{\circ}\text{C}$ (-40° to 176°F)

■ INSTALLATION LOAD CELL

- Available to use the same load cell of 8pcs (350Ω standard)
- A ground should be installed horizontal
- Installing over 2pcs of load cell, please connect each line in parallel and Insert a variable resistor under 50Ω in EX + line and minimize a output
 - Accuracy of load cell.
 - It may occur a weight error by each accuracy of load cell.
- It may occur a weight error in case of a temperature variation of load cell
- Please weld(elect spark) at the place installed with load cell and equipments,
 - Divide the power into a connector of load cell in inevitable case
- Please connect the below construction of load cell with the above ones using The earth to the weighing part weighing a material occurring a electro sparks.

3. Features

- 24bit sigma-delta A/D converter for high accuracy Easy
- Full digital calibration
- Simulative(mV/V memory) or live load calibration
- Peak hold and remote auto zero, tare
- High brightness VFD display
- A compact Appearance by DIN regulations (DIN 193 x 96 Panel system)
- Easy to preset, change, confirm the weight value by the numeral key.
- Weight Memory function even in electro spark case.
- Watch-Dog timer guards for self-diagnostics.
- Set up to 1/20,000 display resolution
- Various specification of weight conversion speed.
(Digital Filter Function)
- Various option and addition for customer's satisfaction such as serial communication, RS-422, Analog output, Current LOOP, Printer, BCD parallel output and so on.

TECHNICAL SPECIFICATION

1. Analog Input & A/D Conversion

Load cell excitation Voltage	DC 10V \pm 5%, 300mA up to 8 x 350ohm load cells
Input sensitivity	0.3 μ V/D
System linearity	Within 0.01% F.S.
Zero adjust range	-1mV ~ 34mV
Input Voltage	Max. 34mV Min. 5mV
Accuracy	Zero drift : \pm 0.2 μ V/ $^{\circ}$ C RTI max. Span drift : 20ppm/ $^{\circ}$ C max.
Input Noise	\pm 0.3 μ V p.p or less
Input Impedance	10 M Ω (Min.)
A/D converter	Sigma-Delta system
A/D internal resolution	Approximately 200,000 counts
A/D external resolution	1/20,000 (Max.)
A/D conversion speed	50 times/sec ~ 2 times/sec
Max. resolution	1/20,000

2. Digital Part

Display	7 Segment VFD, 6-Digits, 13mm(Height)
Display below zero	"-" minus signal
Additional symbols	Stable, Zero, Relay Point(L1~L4), TARE
Min. Division	x1, x2, x5, x10, x20, x50, x100, x200
Decimal Point	0, 0.0, 0.00, 0.000, 0.0000

3. Technical

AC adapter	AC 110/220V \pm 10%, 50/60Hz
Power consumption	20 VA
Data Memory	10 year
Operating temperature	-10°C~+40°C (+14°F ~ +104°F)
Humidity	85% Rh Max.
Overall dimensions	193(W) x 162(D) x 96(H)
Weight	2.5 kg

4. Option

STANDARD	Serial Interface : RS-232C
Option - 1	Serial Interface : RS-422, 485
Option - 2	Serial Interface : Current Loop
Option - 3	Analog Output : 0~10V
Option - 4	Analog Output : 4~20mA
Option - 5	Parallel Interface : BCD OUTPUT

DIMENSIONS

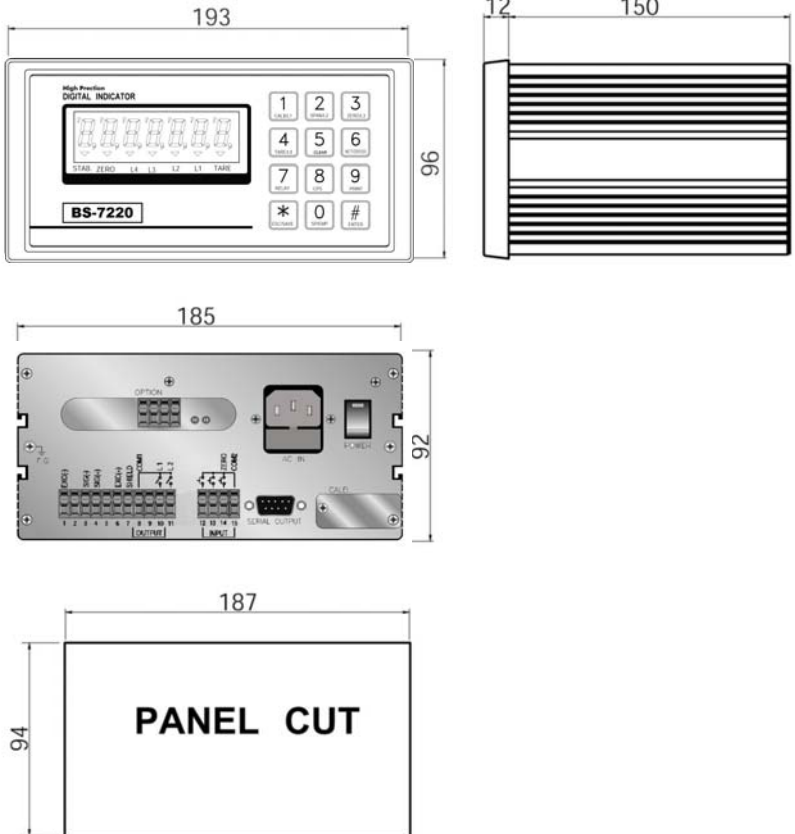

Front Panel

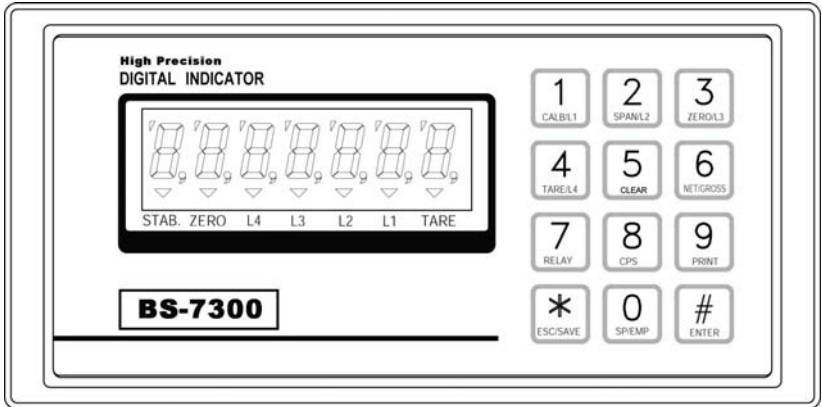

1. Display Lamp (▼)

- ▼ **STABLE Lamp** : ON when the weight is stable.
- ▼ **ZERO Lamp** : ON when the current weight is 0 kg.
- ▼ **L1 Lamp** : : It will lamp when 1step control works
- ▼ **L2 Lamp** : : It will lamp when 2step control works
- ▼ **L3 Lamp** : : It will lamp when 3step control works
- ▼ **L4 Lamp** : : It will lamp when 4step control works
- ▼ **TARE Lamp** : ON when the tare weight is stored.

This Lamp will be switched to Net mode

2. Keyboard

* The Key operating can be permitted or prohibited by dip switch.

* When pushing the key, it sounds "OK".

* Each Key works either a single function or compound functions.

A compound function key will be a command key when it push first and According to the command key, the fixed value works its function,

The key to finish a input data is ENTER Key.

2-1. CALIBRATION & LOCK Mode Key Functions



CALB mode : Simulative calibration or Number 1
 LOCK mode : Number 1 or Analog output weight value
 Set L1 range



CALB mode : Live calibration or Number 1
 LOCK mode : Number 2
 Set L2 range



CALB mode : ZERO or Number 3
 LOCK mode : ZERO or Number 3
 Set L3 range



CALB mode : Digital Filter Condition or Number 4
 LOCK mode : TARE or Number 4
 Set L4 range



CALB mode : Relay Mode Condition or Number 5
 LOCK mode : HOLD Value Reset or Number 5



CALB mode : Minimum Grade Setting or Number 6
 LOCK mode : NET/GROSS Conversion or Number 6



CALB mode : Motion Detect Condition Setting or Number 7
 LOCK mode : Relay Range Setting or Number 7



CALB mode : Serial Interface Condition or Number 8
LOCK mode : Fall Range Setting or Number 8



CALB mode : Zero Tracking or Number 9
LOCK mode : Printer or Number 9



CALB mode : Decimal point setting or Number 0
LOCK mode : Number 0
Set EMPTY range



CALB mode : Data Input Cancel or SAVE
LOCK mode : Data Input Cancel or SAVE



CALB mode : Command or Start and set up display digit
LOCK mode : Command or Start and set up display digit

Rear Panel

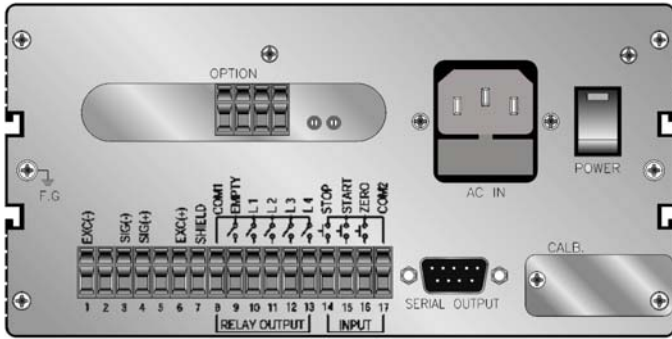

POWER : Power ON, OFF switch

It will be safe to use it after 10minuate for a precise measurements.

■ **AC IN** : Available to change AC110/220V with multiple.
Before setting up, please confirm the power voltage.
Please change the connect terminal of 110V/220V after opening the cover
If you need to change. (It was settled with AC220V at the first)
Use a stable power supply AC110/220V $\pm 10\%$, 50/60Hz

■ **FUSE** : Please use the standard approved .
FUSE AC250V, 0.5A (a glass tube with small type)

■ **F.G** : Please earth it for safe.

■ **LOAD CELL** Please connect the indicator connector with the wire of load cell according to the color.

Pin no.	SIGNAL	
1	Load cell Input Voltage (-)	EXC- (White)
3	Load cell output (-)	SIG- (Blue)
4	Load cell output (+)	SIG+ (Green)
6	Load cell Input Voltage (+)	EXC+ (Red)
7	Shield	SHIELD

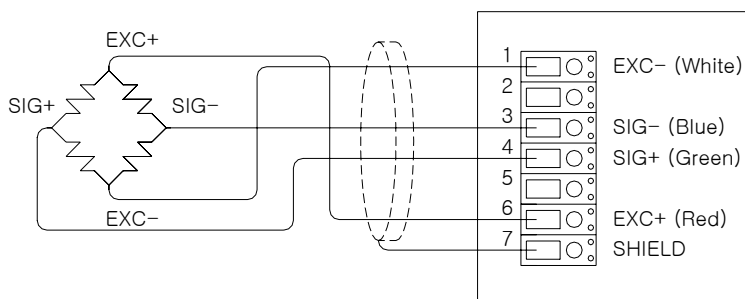

The wire color of load cell according to a manufactures.

	1 EXC-	3 SIG-	4 SIG+	6 EXC+	7 SHIELD
BONGSHIN	WHITE	BLUE	GREEN	RED	SHIELD
CAS, TMI, AND	WHITE	BLUE	GREEN	RED	SHIELD
BLH	BLACK	RED	WHITE	GREEN	YELLOW
INTERFACE	BLACK	WHITE	GREEN	RED	SHIELD
KYOWA	BLACK	WHITE	GREEN	RED	SHIELD
P.T.	BLACK	WHITE	GREEN	RED	SHIELD
SHOWA	BLUE	BLACK	WHITE	RED	SHIELD
SHINKOH	BLACK	WHITE	GREEN	RED	SHIELD
TML	BLACK	GREEN	WHITE	RED	SHIELD
TFAC	BLUE	BLACK	WHITE	RED	YELLOW
HUNTLEIGH	BLACK	WHITE	RED	GREEN	SHIELD

※ Because wire color may be different according to a manufacture and load cell models. Please refer for the data sheet of load cell.

■ **OUT-PUT** : COM1, EMPTY, L 1, L 2, L 3, L4

Connect between COM terminal and OUTPUT terminal
With the earth of no electric power.

Please use the output data For a signal only, don't use it for working.

Max earth capacity : AC250V / 0.5A

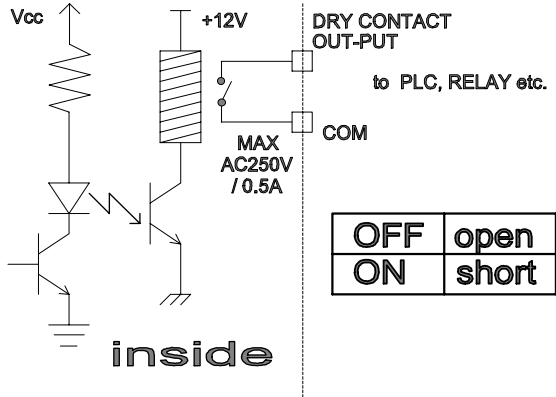

■ **IN-PUT** : COM2, STOP, START, ZERO

This key is to control a equipment from the outside .

Please connect between COM terminal and each input terminal .
Because the power of input terminal was connected with 12V voltage
From the inside.

- * An electric current is about 10mA.
- * Please make the minimum time to input a data with over 50mSEC.

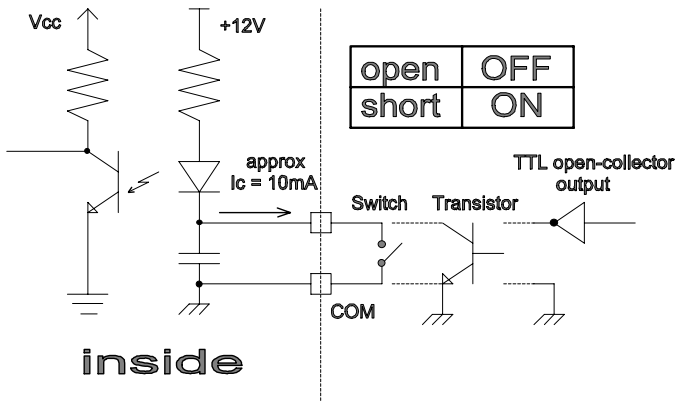

■ LOCK Switch

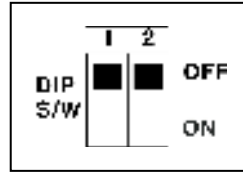
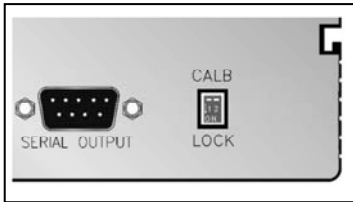

Dip slide sw 1 : CALIBRATION & LOCK mode

SW 1 ON (Down) : Shift to lock mode. (weighing mode)

SW 1 OFF (Up) : Shift to calibration mode.

Dip slide sw 2 : Not used

■ SERIAL OUTPUT

STANDARD	Serial Interface : RS-232C
Option - 1	Serial Interface : RS-422
Option - 2	Serial Interface : Current Loop

■ Option

Option - 3	Analog Output : 0~10V
Option - 4	Analog Output : 4~20mA
Option - 5	Parallel Interface : BCD OUTPUT

Installation

☞ GENEANL RULES

- Avoid sudden Collision, vibration, temperature, water, wind
- Use a stable power supply 110V/220V \pm 10% 50/60Hz
Set up voltage **220V**
(Adjust the power voltage because the choice terminal of power is inside.)
- Connect and power off the switch when connecting the external equipments.
- Ensure to earth Indicator to equipments
- Ensure to calibrate and set up it for operating.

* PARTS

- POWER CODE : 1EA
- FUSE : 1EA (PIPE TYPE 250V 0.5A SMALL TYPE)
- OPERATING MANUAL : 1EA
- A Stable Connector for Option installation.

► TERMINAL BLOCK

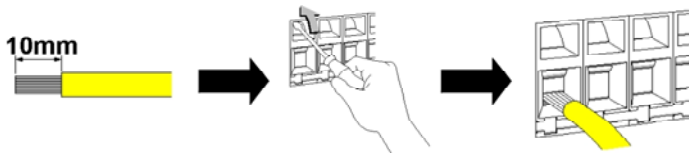

► FUSE

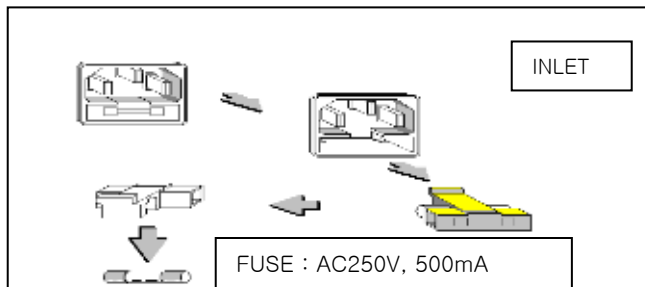

Calibration mode (Actual weight)

■ What is Calibration?

Calibration is to adjust max weight, minimum division, decimal point displayed to Indicator. To the actual weight worked by load cell.

☞ It should calibrated certainly when load cell or indicator will be changed.

1. SPAN ADJUSTMENT

■ what is span adjustment.

Span adjustment is to make the display value from "0" to max weight consistent to the actual weight.

2. Calibration Menu (1 Step ~ 10 Step)

- 1 Step : Calibration Mode Set
- 2 Step : Minimum Division Set
- 3 Step : Maximum Capacity Set &
Rated Output value Set
- 4 Step : Digital Filter Value Set
- 5 Step : Decimal Point Set
- 6 Step : Zero Calibration
- 7 Step : Span Calibration
- 8 Step : Relay mode Set
- 9 Step : Save
- 10 Step : END

■ Step 1

– Function : **Calibration Mode Set (Dip switch set)**

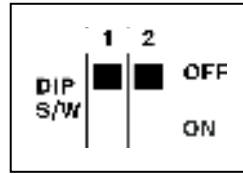
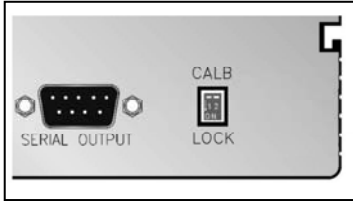

Dip slide sw 1 : CALIBRATION mode

SW 1 OFF (Up) : Shift to calibration mode.

■ Step 2

– Function : **Minimum Division Set**

Range → 1~ 8

A step to set up a division value.

Also this value will be displayed as 1-2-5-10-20-50-100 by each key.

So, it will be go to the next step recording the position.

Key	Display	Description
	X	0.001Kg (Decimal point: 3)
	X	
	1	
	0.000	

1 : 1,2,3,4,5...
 2 : 2,4,6,8,10...
 3 : 5,10,15,20,25...
 4 : 10,20,30,40,50...
 5 : 20,40,60,80,100...
 6 : 50,100,150,200,250...
 7 : 100,200,300,400,500...
 8 : 200,400,800,1000...

- ☞ REF 1. The minimum division means the value of one division.
- ☞ REF 2. External resolution is obtained by division the min. division by the maximum capacity. Set the resolution to be within 1/10,000.

■ Step 3

– Function : **Maximum Capacity Set &**

Range → 1 ~ 99,900kg

A step to set up max. weight.

It can input the maximum weight as the end-user demands instead of discretion number.

How to input is to push **ENTER** key after inputting discretion number.

- ♣ Don't excess (A division ÷ Max. weight) with over 1/10,000

If accessing over 1/10,000, it will appear error.





– Function : **Rated Output value Set**

Range → 1.0000 mV/V ~ 3.0000 mV/V

The display discretion number "r2.0000" (rated output 5figure)

Please input the value of standard weight for span adjustment by numeric key.

How to input is to push **ENTER** key after inputting discretion number.

Key	Display	Description
	XX.XXX	
	XX.XXX	
Full Capacity Value Input (xxxxx)	XX.XXX	
	X.XXXX	
Load Cell Rated Output Value Input (xxxxx)	X.XXXX	mV/V
	0.000	

☞ REF 1. The maximum capacity means the maximum weight that scale can measure.

☞ REF 2. A data sheet is attached to a strain-gage sensor at the time of purchase.

The data sheet provides data including:

capacity load(in kg, t, etc.)

rated output. Voltage(in mV/V)

non-linearity, Hysteresis, input resistance, output resistance and zero balance.

Enter the capacity and the rated output value required for equivalent input calibration into the BS-7300.





■ Step 4

– Function : **Digital Filter Setting**

Range → 1~9

Adjust the set value according to the condition how many times converted digital value read and display.



How to input is to push **ENTER** key after inputting discretion

Key	Display	Description
	X	
	X	
	3	1 : Less vibration ~
	0.000	9 : Much vibration

■ Step 5

– Function : **Decimal Point Set**

Range → 0~ 4

Key	Display	Description
	X	
	3	0 (10^0) : 0 1 (10^1) : 0.0 2 (10^2) : 0.00
	0.000	3 (10^3) : 0.000 4 (10^4) : 0.0000



■ Step 6

– Function : **Zero Calibration**

A step to check the zero conditions of Indicator.

After appearing "ZEro", please push **ENTER** key.

Please do it as the zero adjustment instruction.

Key	Display	Description
	0	Unload the tray and press
	ZEro	"ENTER" key Under zero calibration
	0.000	Zero calibration is completed.

- ☞ REF 1. If the "ZERO" key is pressed, only zero calibration is completed and program moves SAVE & EXIT mode.
please push **ESC** key.

■ Step 7

– Function : **Setting Weight In Span Calibration**

Range → 1~ 99,900kg

The display discretion number "10.000" (span 5figure)

Please input the value of standard weight for span adjustment by numeric key.

How to input is to push **ENTER** key after inputting discretion number.

Please put the span standard weight on the platform.(the weight is 10000kg at here)

Press **ENTER** key after stable of platform.



(Notice) If indicator is unmatched with load cell capacity or span standard weight, indicator will display error message .

This value of span standard weight must be equal to full capacity, or over 10% of full capacity.

(In case of less 1/5,000 resolution ,the value of standard weight must be over 10% of full capacity at least.)

(In case of over 1/5,000 resolution ,the value of standard weight must be over 20% of full capacity at least.)

(Notice) If span capacity is set less 10% , indicator will display error message.

Key	Display	Description
	XX.XXX	Load the weight which was set in span value and press "ENTER" key. Under span calibration
	XX.XXX	
Weight Load	XX.XXX	
Weight Value Input (xxxxx)	XX.XXX	
	SPAn	Span calibration is completed.
Weight Load Display	XX.XXX	

☞ REF 1. The weight shall be within the range of 10%~100% of maximum weight.

☞ REF 2. The setting weight must be over the range of 10% of maximum weight.

☞ REF 3. The setting weight over the maximum capacity.

☞ REF 4. If zero calibration is done without any error, "SPAn" message is displayed the weight of setting weight is displayed on LED screen.
Check the weight.

☞ REF 5. Check the weight of setting weight.

■ Step 8





– Function : **Relay Mode Set**

Range → 0 or 8

Two kinds of way of input set point are available.

This key is used for sum of unit weight and relay mode or numeric key "5" .

Press the "5" key, appear the "x" on the unit display part.

Key	Display	Description
	x	
	x	
	1	0 : No relay output signal
	0.000	1 : Batch weighing output signal (3point)
		2 : Batch weighing output signal (4point)
		3 : Discharge weighing output signal (external)
		4 : Comparator weighing output signal
		5 : Accumulate weighing output signal (3point)
		6 : Accumulate weighing output signal (4point)
		7 : Auto accumulate weighing output signal (3point)
		8 : Auto accumulate weighing output signal (4point)

Relay mode 1 : Batch weighing output signal (3point)

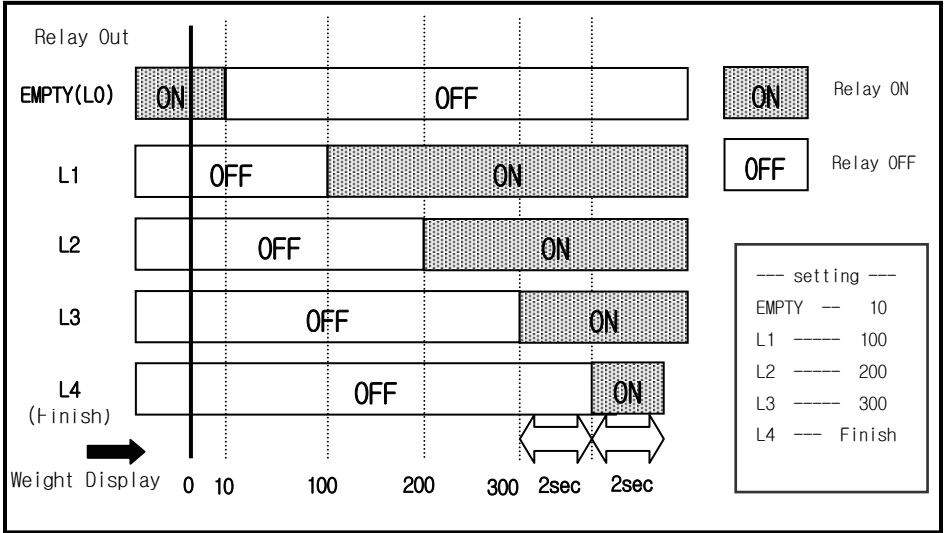

Relay mode 2 : Batch weighing output signal (4point)

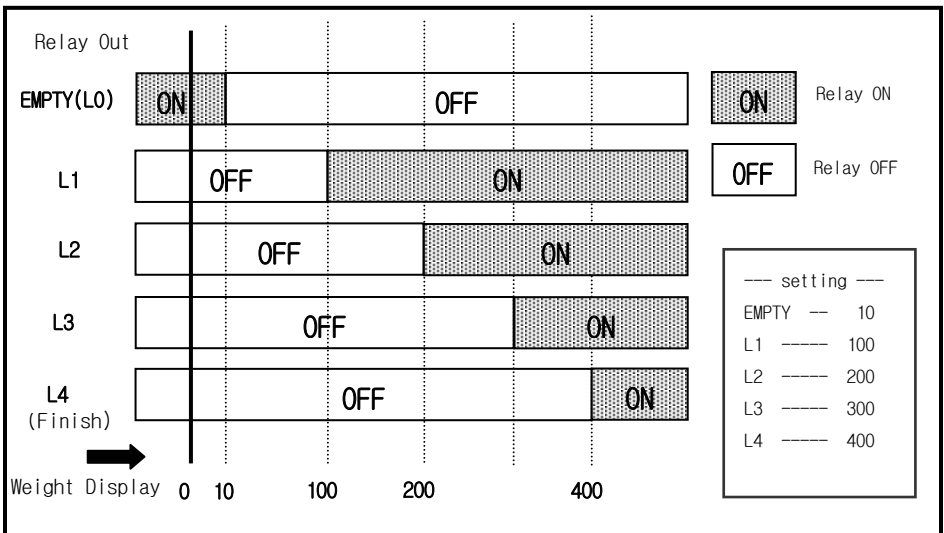

Relay mode 3 : Discharge weighing output signal (external)

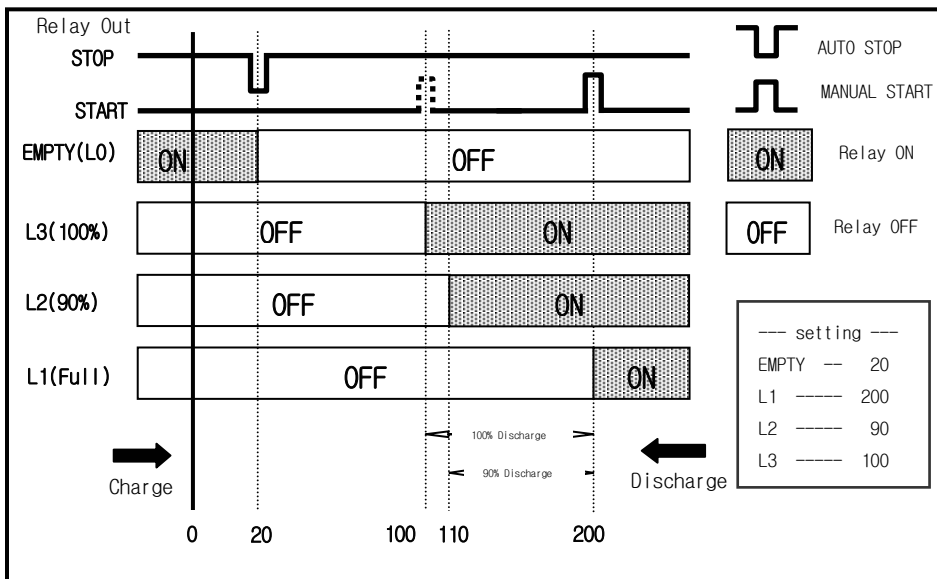

Relay mode 4 : Comparator weighing output signal

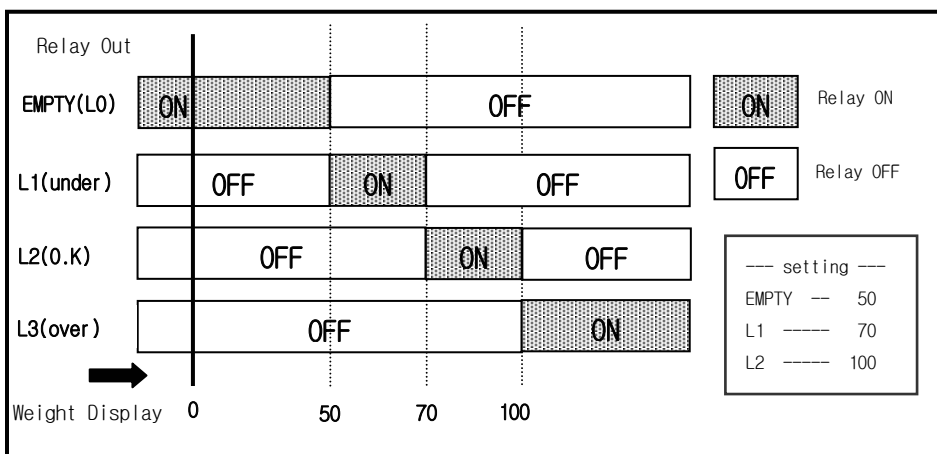

Relay mode 5 : Accumulate weighing output signal (3point)

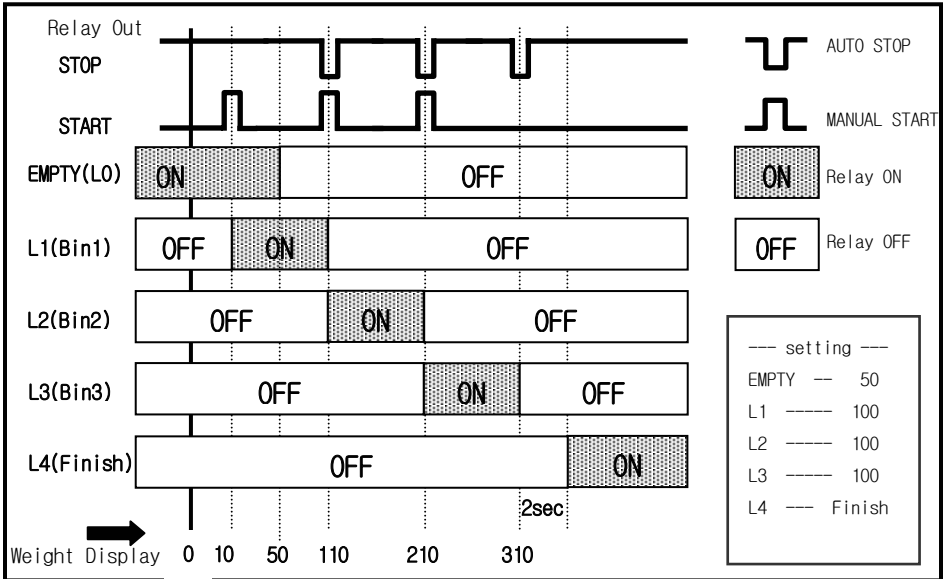

Relay mode 6 : Accumulate weighing output signal (4point)

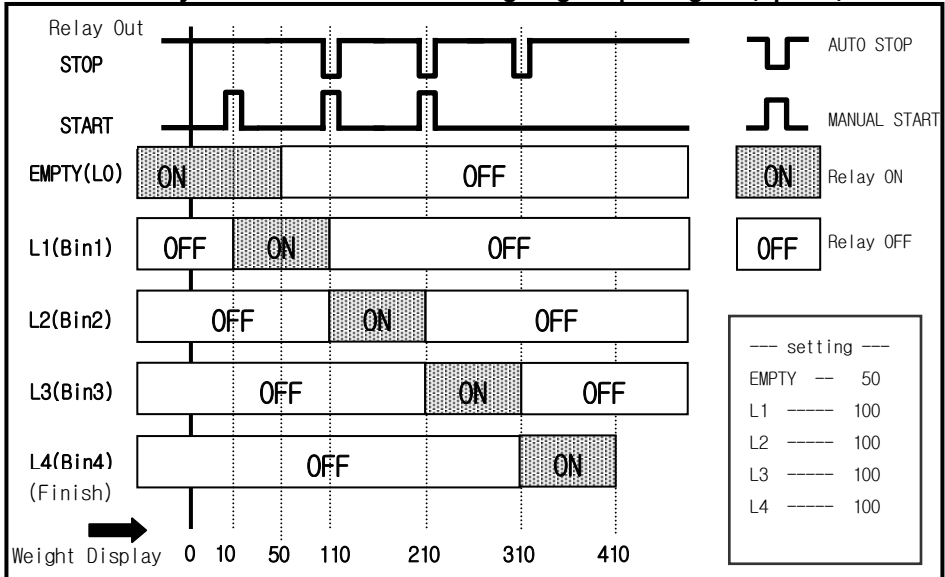

Relay mode 7 : Auto Accumulate weighing output signal (3point)

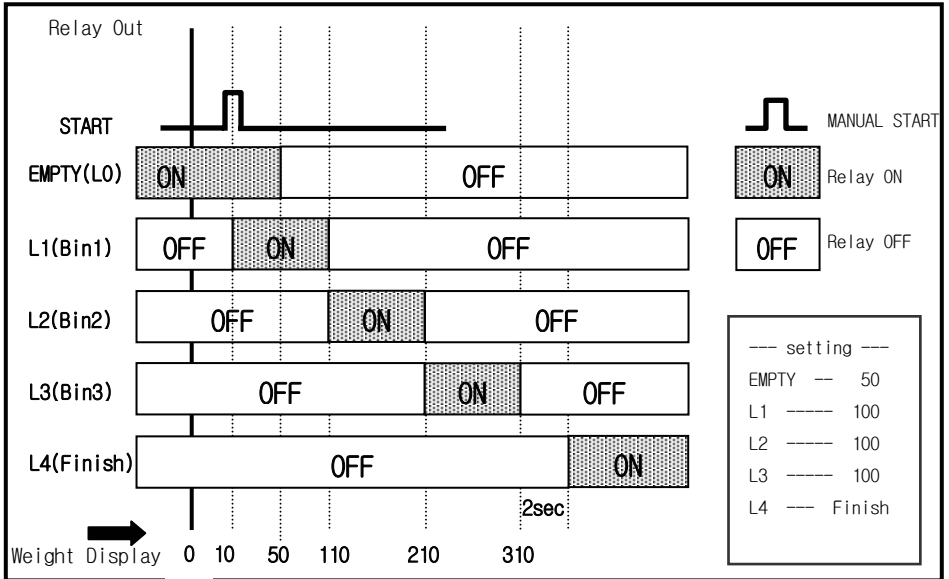

Relay mode 8 : Auto Accumulate weighing output signal (4point)

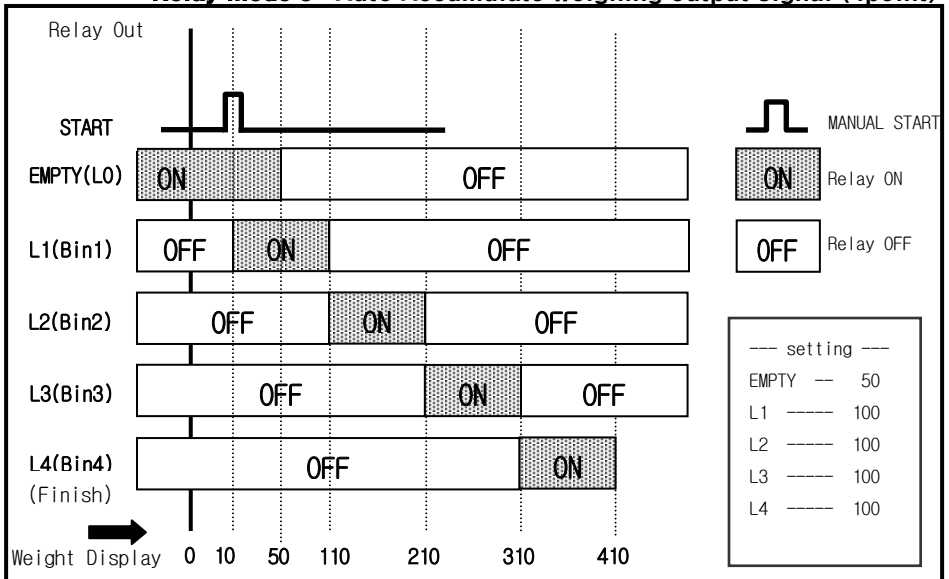



■ Step 9

– Function : **SAVE**

The "SAVE" message is displayed in 8 step,
all span adjustment is end.

Span calibration is completed.

Key	Display	Description
	SAVE	Store and move into next menu
	SAVE	
	Proc	
	0.000	

■ Step 10

– Function : **END**

The indicator will enter into user's weighing mode.

LOCK Switch

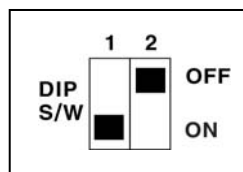
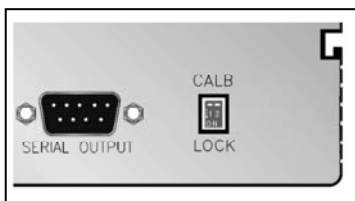

Dip slide sw 1 : LOCK mode

SW 1 ON (Down) : Shift to lock mode. (weighing mode)

Calibration mode (Simulation weight)

■ What is Simulation Calibration?

Calibration is performed for matching the BS-7300 to a strain-gage sensor. The following two type of calibration are available for the BS-7300.

1. Simulation ADJUSTMENT

■ Equivalent input Calibration.

Calibration is performed without an actual load by entering the rated output value (mV/V) and the capacity (to be indicated) of the strain-gage sensor by the keys. Calibration is easily performed when no actual load is available.

For example, the gain is automatically determined by entering.
2.0000mV/V (rated output)–100.0kg (capacity)
as indicated for a load.

2. Calibration Menu (1 Step ~ 10 Step)

- 1 Step : Calibration Mode Set
- 2 Step : Minimum Division Set
- 3 Step : Decimal Point Set
- 4 Step : Maximum Capacity Set &
Rated Output value Set
- 5 Step : Zero Calibration
- 6 Step : Digital Filter Value Set
- 7 Step : Relay mode Set
- 8 Step : Save
- 9 Step : END

■ Step 1

– Function : **Calibration Mode Set (Dip switch set)**

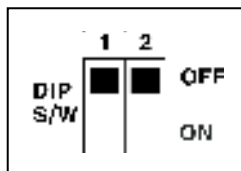
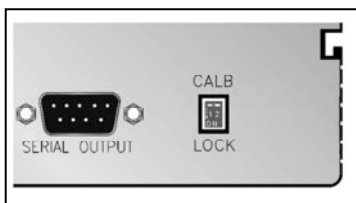

Dip slide sw 1 : CALIBRATION mode

SW 1 OFF (Up) : Shift to calibration mode.

■ Step 2

– Function : **Minimum Division Set**

Range → 1~ 8

A step to set up a division value.

Also this value will be displayed as 1-2-5-10-20-50-100 by each key.

So, it will be go to the next step recording the position.



Key	Display	Description
	X	
	X	
	1	0.001Kg (Decimal point: 3)
	0.000	1 : 1,2,3,4,5... 2 : 2,4,6,8,10... 3 : 5,10,15,20,25... 4 : 10,20,30,40,50... 5 : 20,40,60,80,100... 6 : 50,100,150,200,250... 7 : 100,200,300,400,500... 8 : 200,400,800,1000...

- ☞ REF 1. The minimum division means the value of one division.
- ☞ REF 2. External resolution is obtained by division the min. division by the maximum capacity. Set the resolution to be within 1/10,000.

■ Step 3

– Function : **Decimal Point Set**

Range → 0~ 4

Key	Display	Description
	X	
	3	0 (10 ⁰) : 0 1 (10 ¹) : 0.0 2 (10 ²) : 0.00 3 (10 ³) : 0.000 4 (10 ⁴) : 0.0000
	0.000	

■ Step 4

– Function : **Maximum Capacity Set &**

Range → 1 ~ 99,900kg

A step to set up max. weight.

It can input the maximum weight as the end-user demands instead of discretion number.

How to input is to push **ENTER** key after inputting discretion number.

♣ Don't excess (A division ÷ Max. weight) with over **1/10,000**

If accessing over **1/10,000**, it will **appear error**.





- Function : **Rated Output value Set**

Range → 1.0000 mV/V ~ 3.0000 mV/V

The display discretion number "2.0000" (rated output 5figure)

Please input the value of standard weight for span adjustment by numeric key.

How to input is to push **ENTER** key after inputting discretion number.

Key	Display	Description
	XX.XXX	
	XX.XXX	
Full Capacity Value Input (xxxxx)	XX.XXX	
	X.XXXX	
Load Cell Rated Output Value Input (xxxxx)	X.XXXX	mV/V
	0.000	

☞ REF 1. The maximum capacity means the maximum weight that scale can measure.

☞ REF 2. A data sheet is attached to a strain-gage sensor at the time of purchase.

The data sheet provides data including:

capacity load(in kg, t, etc.)

rated output. Voltage(in mV/V)

non-linearity, Hysteresis, input resistance, output resistance and zero balance.

Enter the capacity and the rated output value required for equivalent input calibration into the BS-7300.



■ Step 5

– Function : **Zero Calibration**

A step to check the zero conditions of Indicator.

After appearing "ZEro", please push **ENTER** key.

Please do it as the zero adjustment instruction.

Key	Display	Description
	0	Unload the tray and press "ENTER" key Under zero calibration
	ZEro	Zero calibration is completed.
	0.000	

☞ REF 1. If the "ZERO" key is pressed, only zero calibration is completed and program moves SAVE & EXIT mode.
please push **ESC** key.





■ Step 6

– Function : **Digital Filter Setting**

Range → 1~ 9

Adjust the set value according to the condition how many times converted digital value read and display.

How to input is to push **ENTER** key after inputting discretion

Key	Display	Description
	X	
	X	
	3	1 : Less vibration ~
	0.000	9 : Much vibration





■ Step 7

– Function : **Relay Mode Set**

Range → 0 or 8

Two kinds of way of input set point are available.

This key is used for sum of unit weight and relay mode or numeric key "5" .
Press the "5" key, appear the "x" on the unit display part.

Key	Display	Description
	x	
	x	
	1	0 : No relay output signal
	0.000	1 : Batch weighing output signal (3point)
		2 : Batch weighing output signal (4point)
		3 : Discharge weighing output signal (external)
		4 : Comparator weighing output signal
		5 : Accumulate weighing output signal (3point)
		6 : Accumulate weighing output signal (4point)
		7 : Auto accumulate weighing output signal (3point)
		8 : Auto accumulate weighing output signal (4point)

Relay mode 1 : Batch weighing output signal (3point)

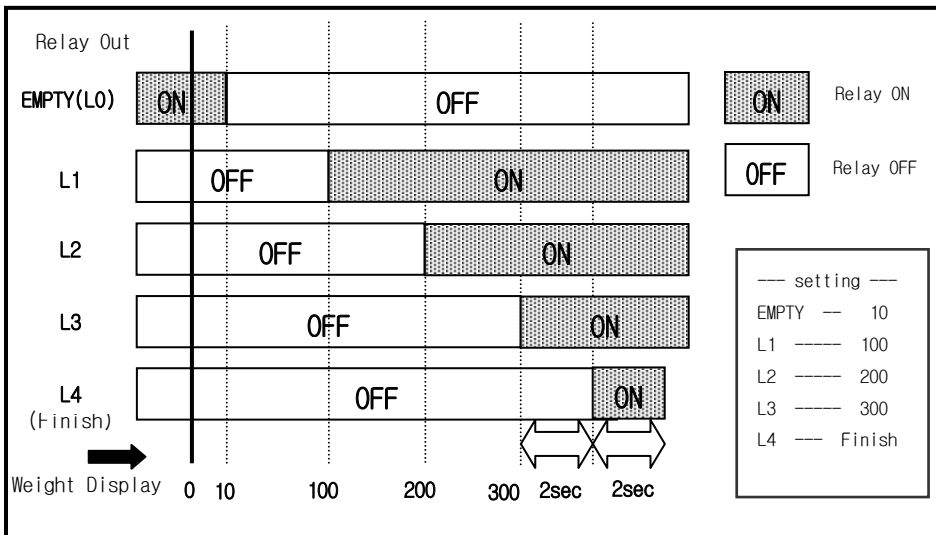

Relay mode 2 : Batch weighing output signal (4point)

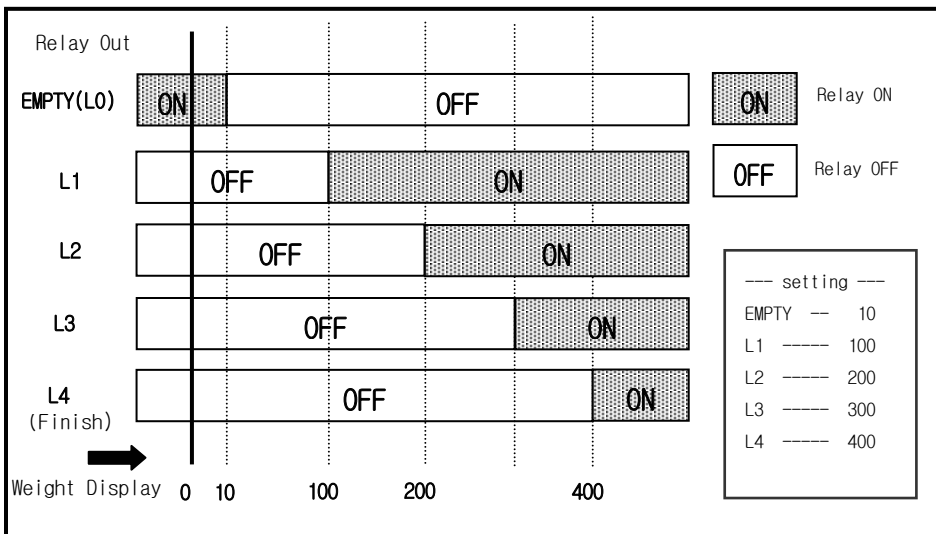

Relay mode 3 : Discharge weighing output signal (external)

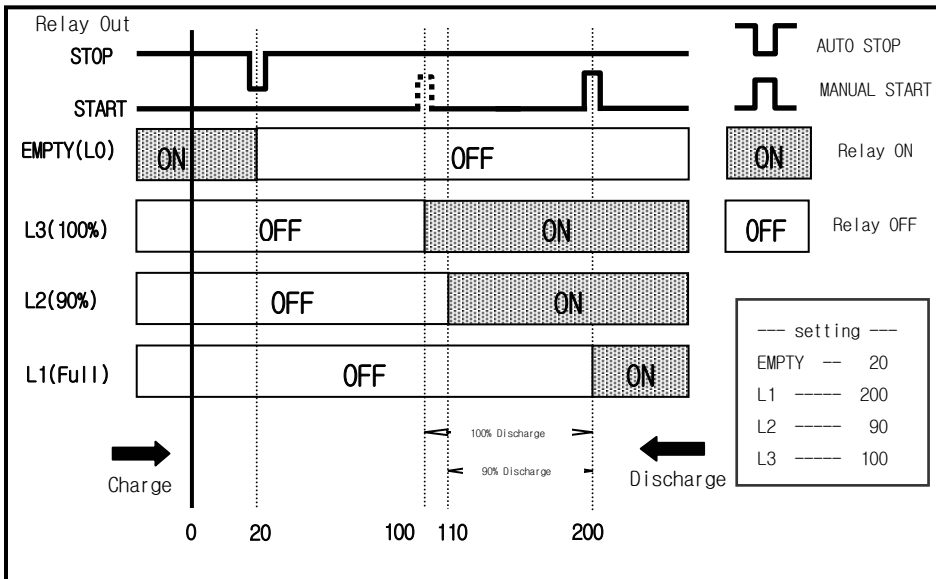

Relay mode 4 : Comparator weighing output signal

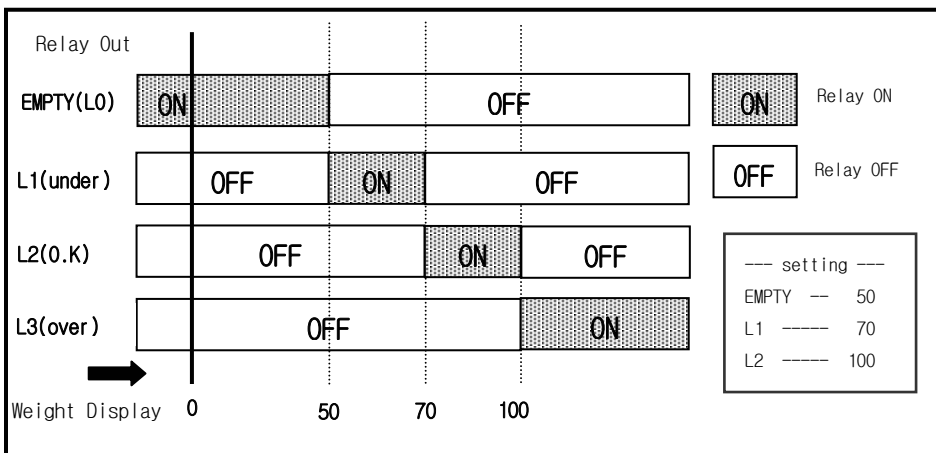

Relay mode 5 : Accumulate weighing output signal (3point)

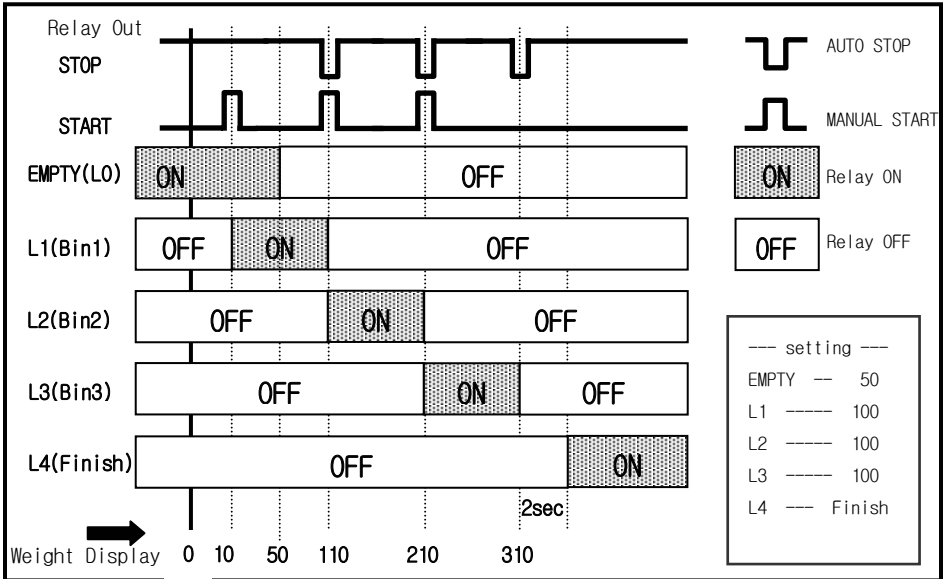

Relay mode 6 : Accumulate weighing output signal (4point)

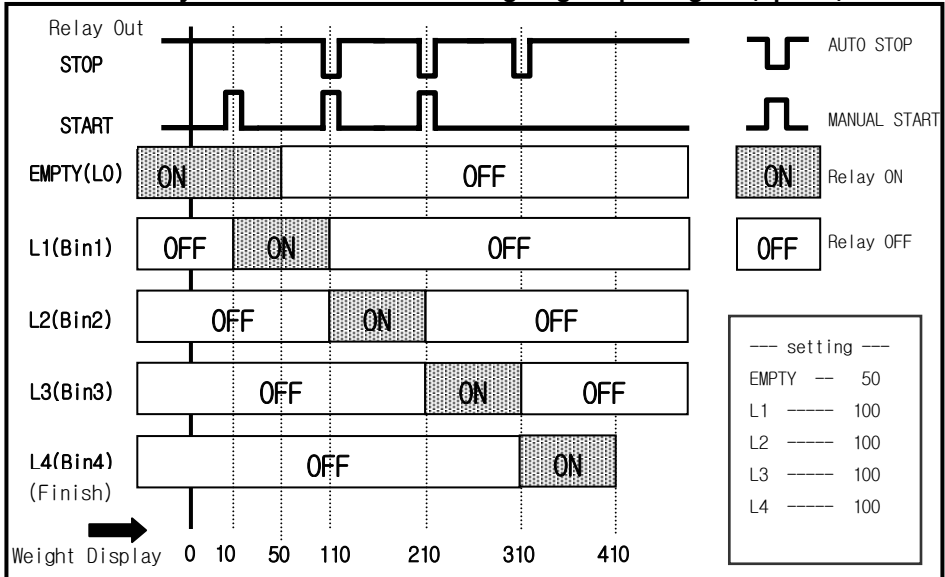

Relay mode 7 : Auto Accumulate weighing output signal (3point)

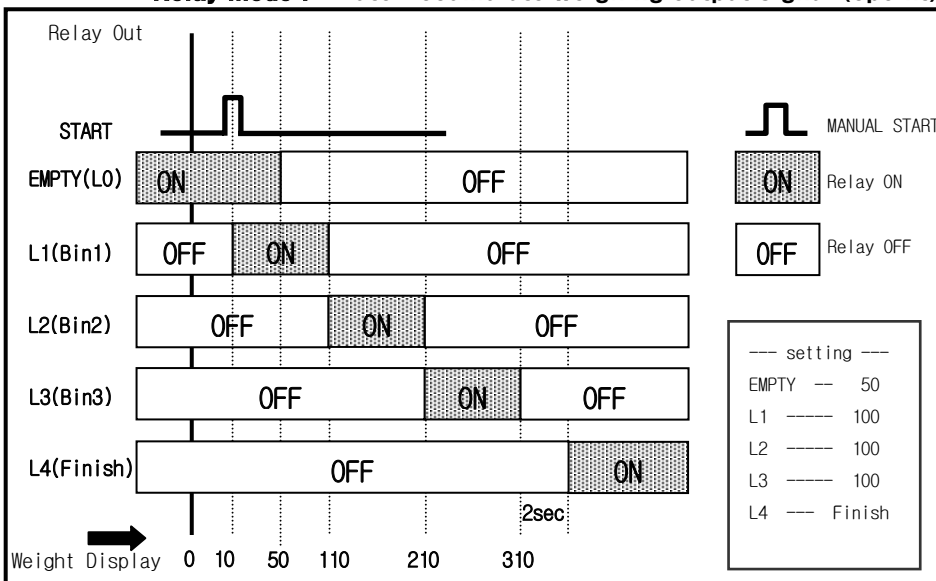

Relay mode 8 : Auto Accumulate weighing output signal (4point)

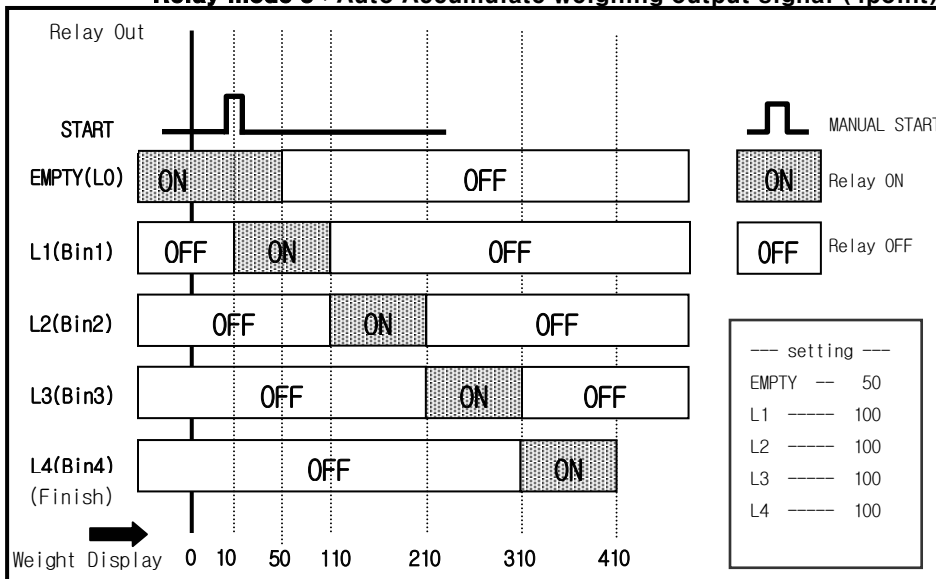



■ Step 8

– Function : **SAVE**

The "SAVE" message is displayed in 7 step,
all span adjustment is end.

Span calibration is completed.

Key	Display	Description
	SAVE	Store and move into next menu
	SAVE	
	Proc	
	0.000	

■ Step 9

– Function : **END**

The indicator will enter into user's weighing mode.

LOCK Switch

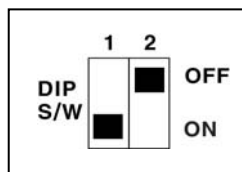
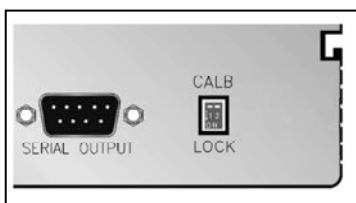



Dip slide sw 1 : LOCK mode

SW 1 ON (Down) : Shift to lock mode. (weighing mode)

SET-UP Mode

1. Un-Lock Mode Key Function

Digital Filter			
	1	1 : Less vibration	Adjust the set value according to the condition how many times converted digital value read and display.
	~	~	
	9	9 : Much vibration	
	0	0 : Fast display	



Motion Detection Condition			
 XX-X	00	No motion Detection Condition	
	01	1 : Less vibration	If weight change within given time is not bigger than the SET range, stable condition is displayed..
	~	~	
	19	19 : Much vibration	

Set Hold Type			
 XX-X	0	No Hold	
	1	Peak Hold : Compute the maximum weight of oscillating weights.	
	2	Average Hold : Compute the average weight of oscillating weights.	
		XX-X-XX Average Hold time : 00~29 sec	

RS-232C Serial output Mode (Data transmission)		
	0	No data output
	1	On lock, every press the “9” key present weight transmission.
	2	Stream mode. Present weight continuously transmission
	3	Transmit only in stable condition. When complete of weighing which is present weight send one time automatically.

Automatic Zero Tracking Compensation			
 <u>XX</u>	0	0 : 0.5 sec	Auto-zero tracking will automatically bring the display back to “0” when there are small deviations..
		1 : 1 sec	
	~	2 : 2 sec	
		~	
	9	9 : 9 sec	

Automatic Zero Tracking Compensation			
 <u>XX</u>	0	None automatic zero	Auto-zero tracking will automatically bring the display back to “0” when there are small deviations..
		1 : 0.5 digit	
		2 : 1 digit	
	~	3 : 1.5 digit	
		~	
9	9 : 4.5 digit		



SAVE	
  	<p>The "SAVE" message is displayed all span adjustment is end.</p> <p>Function calibration is completed.</p>





2. Lock Mode Key Function





TARE Key	
	<p>– Automatic tare weight input –</p> <p>Use container in weighing.</p> <p>Current weight is memorized as tare weight.</p> <p>If you press TARE key in unload condition, Tare setting is released automatically.</p>





CLEAR Key	
	<p>– HOLD Value Reset –</p> <p>If you press CLEAR key, the hold weight are cleared.</p>





NET/GROSS Key	
	<p>- NET/GROSS Conversion -</p> <p>Use container in weight.</p> <p>TARE lamp off – gross weight</p> <p>TARE lamp on –net weight</p> <p>In case tare weight is registered, tare and item's total weight is G. weight and only item's weight is N. weight.</p>





RELAY Value Setting (L0 : EMPTY)		
Key	Display	Description
	L0	
	XX.XXX	
Relay L0 Value Input (xxxxx)	XX.XXX	
	0.000	

RELAY Value Setting (L 1)		
Key	Display	Description
	L0	
	L1	
	XX.XXX	
Relay L1 Value Input (xxxxx)	XX.XXX	
	0.000	





RELAY Value Setting (L 2)		
Key	Display	Description
	L0	
	L2	
	XX.XXX	
Relay L2 Value Input (xxxxx)	XX.XXX	
	0.000	

RELAY Value Setting (L 3)		
Key	Display	Description
	L0	
	L3	
	XX.XXX	
Relay L3 Value Input (xxxxx)	XX.XXX	
	0.000	





RELAY Value Setting (L 4)		
Key	Display	Description
	L0	
	L4	
	XX.XXX	
Relay L4 Value Input (xxxxx)	XX.XXX	
	0.000	

FALL Value Setting (L 1)		
Key	Display	Description
	L1	
	L1	
	XX.XXX	
Relay L1 Fall Value Input (xxxxx)	XX.XXX	
	0.000	





REF 1. L1 RELAY SET VALUE – L1 RELAY FALL VALUE
= L1 RELAY OUTPUT

FALL Value Setting (L 2)		
Key	Display	Description
	L1	
	L2	
	XX.XXX	
Relay L2 Fall Value Input (xxxxx)	XX.XXX	
	0.000	

REF 1. L2 RELAY SET VALUE – L2 RELAY FALL VALUE
= L2 RELAY OUTPUT

FALL Value Setting (L 3)		
Key	Display	Description
	L1	
	L3	
	XX.XXX	
Relay L3 Fall Value Input (xxxxx)	XX.XXX	
	0.000	

REF 1. L3 RELAY SET VALUE – L3 RELAY FALL VALUE
= L3 RELAY OUTPUT

FALL Value Setting (L 4)		
Key	Display	Description
	L1	
	L4	
	XX.XXX	
Relay L4 Fall Value Input (xxxxx)	XX.XXX	
	0.000	

REF 1. L4 RELAY SET VALUE – L4 RELAY FALL VALUE
= L4 RELAY OUTPUT

PRINT Key

- PRINT -

By pressing "PRINT" key, "Print" message is displayed.

Set in un-lock mode RS-232C interface "9" key : 1.

SAVE

The "SAVE" message is displayed all span adjustment is end.

Function calibration is completed.

Option

1. RS-232C Serial Interface (STANDARD)

RS-232C Serial output Mode (Data transmission)		
	0	No data output
	1	Press the "9" key present weight transmission.
	2	Stream mode.
	3	Transmit only in stable condition.

► Signal Format

- Type : EIA-RS-232C
- Method : Full-Duplex , Asynchronous, Bi-direction
- Baud rate : 9600bps (Baud-Rate)
- Format :
 - ① Data Bit : 8 (NO Parity)
 - ② Start/Stop : 1 bit
 - ③ Parity Bit : None
 - ④ Code : ASCII

OUTPUT	1	2	3	4	5	6	7	8	9	10	11	12	13	14
Character	CR	LF	ST	SI	DATA (8byte)								CR	LF
HEX Code	0D	0A		+/-	0x30 -0x39 (7Byte) + .0x2E(1byte)								0D	0A

- CR : 0x0D (Carriage Return, EOL)
- LF : 0x0A (Line Feed, NL)
- ST : 0x53 (Stable), 0x55 (Unstable), 0x50 (Peak)
- SI : Sign 0x2B(+), 0x2D(-)
- DATA : ASCII 8byte

Example) : 40.500kg Present weight

OUTPUT	1	2	3	4	5	6	7	8	9	10	11	12	13	14
Character	CR	LF	U	(+)	0	0	4	0	.	5	0	0	CR	LF
HEX Code	0D	0A	55	2B	30	30	34	30	2E	35	30	30	0D	0A

► **RS-232C port connection**

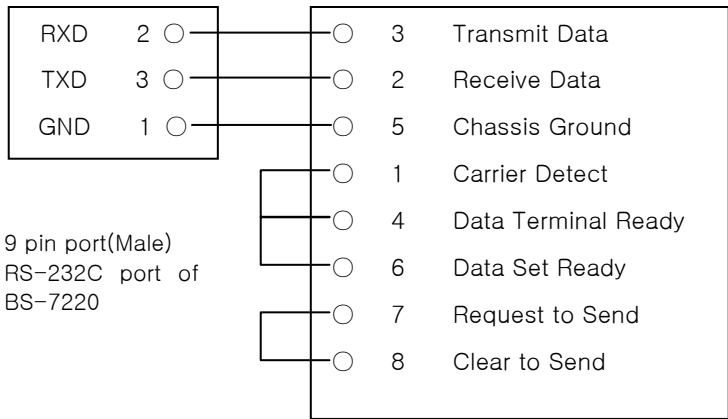
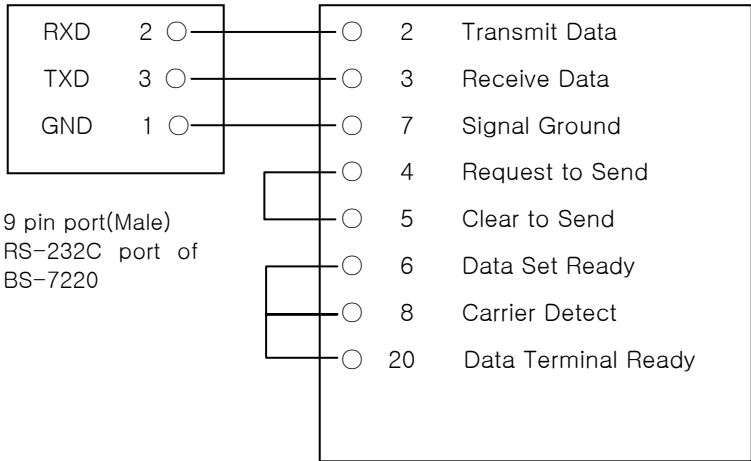

► Simple Interface Program**■ Basic Program**

```
10 OPEN "COM1:9600,N,8,1" As #1
20 IF LOC(1) = 0 THEN 60
30 A$ = INPUT$(1,1)
40 PRINT A$ ; " ";
50 GOTO 20
60 B$=INKEY$ : IF B$ = " " THEN 20
70 PRINT B$ ; " ";
80 PRINT #1,B$:
90 GOTO 20
```

■ C Program

```
#include <bios.h>
#include <conio.h>
#define COM1          0
#define DATA_READY  0×100
#define TRUE          1
#define FALSE         0
#define SETTINGS     0×E3
int main(void)
{
    int in, out, status, DONE = FALSE;
    bioscom(0, SETTINGS, COM1);
    printf("…BIOSCOM [ESC] to exit …\n");
    while (!DONE)
    {
        status = bioscom(3, 0, COM1);
        if (status & DATA_READY)
            if ((out = bioscom(2, 0, COM1) & 0×7F) != 0)
                putchar(out);
            if (kbhit())
            {
                if ((in = getch()) == '×1B')
                    DONE = TRUE;
                bioscom(1, in, COM1);
            }
    }
    return 0;
}
```

2. RS-422 Serial Interface (Option-01)

- RS-422 is to transmit the signal by the power difference.
Also, it is more safety rather other interface system for a electric noise.
- Specially please use the cable with shield coax cable surely.
- Recommended distance is under 1.2 km.
- Both end side of a wire must be connected by the termination of 300Ω .

▶ **Signal Format** : Same as RS-232C

▶ **Data Format** : Same as RS-232C

▶ **Connecting method of RS-422 port**

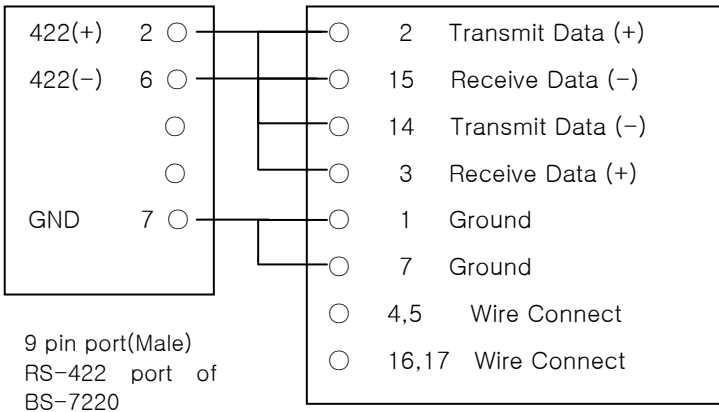

25 pin serial port of computer

3. CURRENT LOOP (Option-02)

► Signal Format

1	20 mA
0	0 mA

■ **Type** : EIA-RS-232C

■ **Method** : Full-Duplex , Asynchronous, Bi-direction

■ **Baud rate** : 2400bps (Baud-Rate)

■ **Format** :

- ① Data Bit : 8 (NO Parity)
- ② Start/Stop : 1 bit
- ③ Parity Bit : None
- ④ Code : ASCII

■ **Data Format**

S	T	,	G	S	,	+	0	0	0	0	0	0	.	0	k	g	CR	LF
Header 1			Header 2			DATA (8byte)						Unit		End				

① Header 1

- US : WEIGHT UNSTABLE
- ST : WEIGHT STABLE
- OL : OVER LOAD

② Header 2

- GS : GROSS WEIGHT MODE
- NT : NET WEIGHT MODE

④ WEIGHT (8 byte)

- SIGNAL (+ or -)
- WEIGHT (Included Decimal point)
 - 100.0 kg : '0', '0', '0', '1', '0', '0', '.', '0',
 - 150.5 kg : '0', '0', '0', '1', '5', '0', '.', '5',
 - 165.3 kg : '-', '0', '0', '1', '6', '5', '.', '3',

Each ASCII code of weight transmitted by 8 byte.('0' : 0 x 20)

⑤ Data for Number

- 2B(H) “ + ” : PLUS
- 2D(H) “ - ” : MINUS
- 2O(H) “ ” : SPACE
- 2E(H) “ . ” : Decimal Point

⑥ Unit

- kg : Unit of kilogram

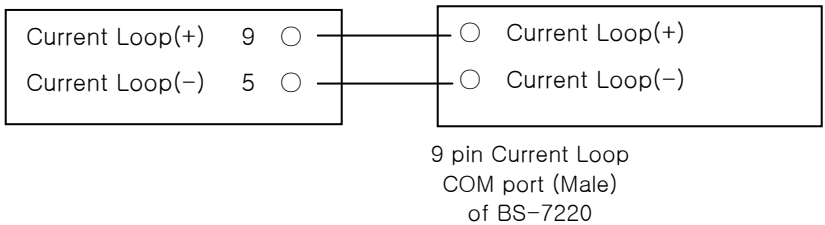
▶ Connecting method of Current Loop RS-232C port

4. Voltage (0~10V) Analog Output (Option-03)

- * The voltage output occurs proportionally the voltage according to the size of a weight
In 0V ~10V.

■ SPECIFICATION

output Voltage	0 ~ 10V DC out
Precision	Max 1/1000
Min Impedance	Over 1 kΩ

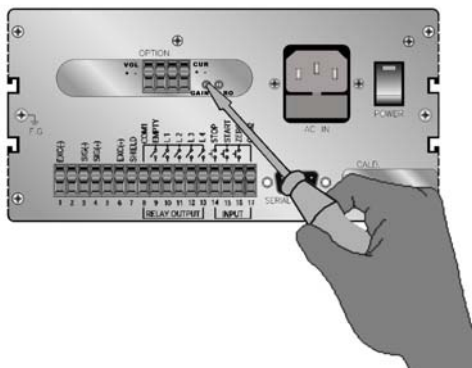

■ Analog Out Standard Weight Selecting.

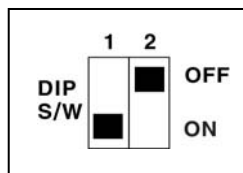
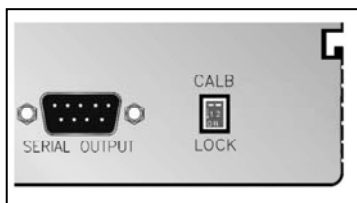

Analog max out value when weight setup.

The indicator will enter into user's weighing mode.











Dip slide sw 1 : LOCK mode

SW 1 ON (Down) : Shift to lock mode. (weighing mode)

Key	Display	Description
	XX.XXX	
	XX.XXX	
Analog max out value input (xxxxx)	XX.XXX	
	0.000	

■ Adjustment

Key	Display	Description
	0	
	ZERo	
ZERO VR adjustment	0.000	
	0.000	
	XX.XXX	
	XX.XXX	
GAIN VR adjustment	XX.XXX	
	0.000	

SAVE	
<div style="text-align: center;">  * ESC/SAVE </div> <div style="text-align: center;">  0 SP/EMP </div> <div style="text-align: center;">  # ENTER </div>	<p>The "SAVE" message is displayed all span adjustment is end.</p> <p>Function calibration is completed.</p>



- * The voltage out is to 0V when the weight is displayed 0 kg in indicator.
- * The voltage out is to 10V when the weight is displayed max. capacity in indicator.
- * If analog output is not correct,
 You can make a fine adjustment with **"ZERO"** VR(Zero adjustment) and **"GAIN"** VR(Span adjustment) on analog pc board by multi meter.
 (Recommended accuracy : 1/1,000)

5. Electric current (4~20mA) Analog Output (Option-03)

- * The voltage output occurs proportionally the voltage according to the size of a weight
In 4mA ~20mA.

■ SPECIFICATION

output Voltage	4 ~ 20 mA DC Current out
Precision	Max 1/1000
Min Impedance	Under 500 Ω

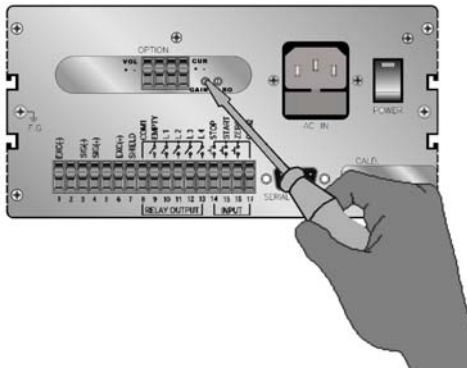

■ Analog Out Standard Weight Selecting.

Analog max out value when weight setup.

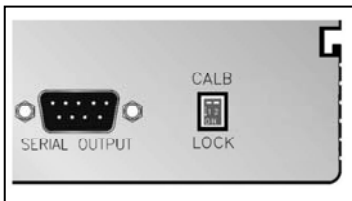

The indicator will enter into user's weighing mode.



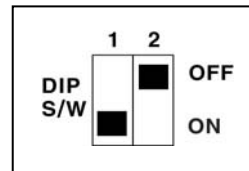



Dip slide sw 1 : LOCK mode





SW 1 ON (Down) : Shift to lock mode. (weighing mode)

Key	Display	Description
	XX.XXX	
	XX.XXX	
Analog max out value input (xxxxx)	XX.XXX	
	0.000	

■ Adjustment

Key	Display	Description
	0	
	ZERo	
ZERO VR adjustment	0.000	
	0.000	
	XX.XXX	
	XX.XXX	
GAIN VR adjustment	XX.XXX	
	0.000	

SAVE	
  	<p>The "SAVE" message is displayed all span adjustment is end.</p> <p>Function calibration is completed.</p>



- * **How to calibrate for output rate between 4mA and 20mA.**
 The current out is to 4 mA when the weight is displayed 0 kg in indicator.
 The current out is to 20 mA when the weight is displayed max. capacity in indicator.
 If analog output is not correct,
 You can make a fine adjustment with “ZERO” VR(Zero adjustment) and “GAIN” VR(Span adjustment)
 On analog pc board by multi meter.

6. BCD Parallel Output (Option-05)

BCD OUTPUT POLARITY		
Ordering information	⓪	Positive Logic
	1	Negative Logic

▣ Connected Pin drawing

PIN NO	SIGNAL	PIN NO	SIGNAL
1	GROUND (GND)	26	Hi : Net LOW : Gross
2	1×10^0	27	STABLE
3	2×10^0	28	
4	4×10^0	29	
5	8×10^0	30	
6	1×10^1	31	
7	2×10^1	32	
8	4×10^1	33	
9	8×10^1	34	
10	1×10^2	35	
11	2×10^2	36	
12	4×10^2	37	EX. Vcc
13	8×10^2	38	
14	1×10^3	39	EX. Vcc
15	2×10^3	40	
16	4×10^3	41	
17	8×10^3	42	Hi : Positive Polarity
18	1×10^4	43	Hi : Decimal Point 10^1
19	2×10^4	44	Hi : " 10^2
20	4×10^4	45	Hi : " 10^3
21	8×10^4	46	Hi :OVER LOAD
22	1×10^5	47	
23	2×10^5	48	
24	4×10^5	49	BUSY
25	8×10^5	50	HOLD (INPUT)

- ▶ 50 PIN CONNECTOR: CHAMP 57-40500(Ampheno1) (Female)
- ▶ TTL OPEN-COLLECTOR OUTPUT
- ▶ HOLD INPUT should be connected with OPEN COLLECTOR TYPE or Switch Earth.

- ▶ And OUTPUT DATA will hold while HOLD INPUT
- ▶ Standard Accessory : Mating connector 57-30500(Ampheno1)
Male 1 EA

■ Weight Data

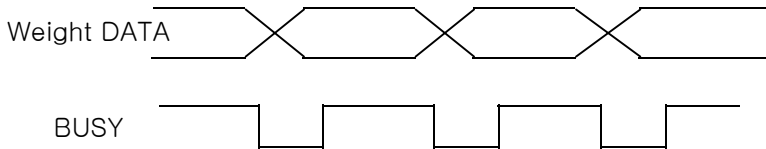

- Signal Logic
- ① Weight BCD DATA OUTPUT → Positive)/Negative .
 - ② POLARITY OUTPUT → “ - ” = L
 - ③ OVER → “ OVER ” = L
 - ④ BUSY → “ BUSY ” = L
 - ⑤ BCD HOLD → “ HOLD ” = L (INPUT)

■ BCD OUTPUT CIRCUIT

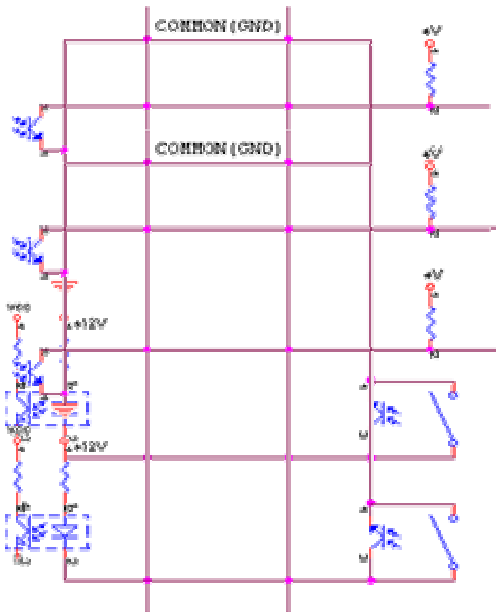

FULLUP RESISTANCE
OUTPUT

Voltage	30V max.
Current	30mA max.

INPUT

- ▶ OUTPUT CIRCUIT IS OPEN COLLECTOR TYPE
- ▶ If output demand TTL LEVEL ,insert full up – resistance to a board of BCD OPTION
- ▶ When inserting a full up resistance ,please change 5v ~ 30V in **37,39 NO**
- ▶ Resistance and Voltage .
 $5V = 1\text{ k}\Omega$, $10V = 2\text{ k}\Omega$, $15V = 2.7\text{ k}\Omega$, $24V = 5\text{ k}\Omega$

Error Message and Trouble Shooting

ERROR	CAUSE	A/S	Reference.
Waving a weight Value.	① Load cell damage ② Insulation resistance badness of load cell. ③ Weighing part error	① Checking for Input, Output of load cell. Resistance Value. ② Checking Insulation Resistance value of Load cell.	① Input resistance : about 420Ω ② Output resistance : about 350Ω ③ Insulation Resistance : over100MΩ
A. Changing a Weight value, B. Not return to ZERO Appear "Ovr -2 (OVER LOAD)	① Load cell damage.	① Checking Insulation Resistance value of Load cell. (Normal Max 100MΩ or -OL-appear)	
	① Disconnected to Load Cell.	① Confirm a connect of Load cell ② Checking a single wire Of load cell cable	
Weight (-) changed	① Load cell output (SIG+,SIG-)changed.	① Load cell connector	
Appear "Ovr -1" (OVER LOAD)	① Load cell damage ② Connection Error	① Load cell damage ② Load cell connector	
	① Excess Max weight	① Remove excess weight	